

OMNI-SYSTEM[®] PLUS

SNOW & ICE DIVISION



OPERATION AND CONFIGURATION MANUAL

TABLE OF CONTENTS

Controller Specifications and Features.....	4
Controller Navigation/Button Assignments.....	5
Body Selection and Diagnostics Connection.....	6
Main Operating Screen—Standard Spreader Body.....	7
Main Operating Screen—Anti-ice/Tow Plow.....	8
Main Operating Screen—Directional Body/Sprayer.....	9
Main Operating Screen—External Equipment Body/Uncontrolled Body.....	10
Operator Adjustments/Datalogging Screens.....	11
Accessing and Navigating Configuration Menu/Firmware Updates.....	12
System Profiles.....	13
Wi-Fi Configuration.....	14
Datalogging Setup.....	15
Global Spreader Settings.....	16-18
Granular Rate/Liquid Rate Setpoints.....	19
Configuration Per Body Selection.....	20-25
Cylinder Configurations (Plow and Hoist).....	26-27
System Alerts.....	28
Notes.....	29

FEATURES & SPECIFICATIONS

Controller Specifications

- Color Touchscreen Display
- Uses LED Back Lighting
- Tactile Switch Controls
- Built-in Audible Alarm
- Ergonomic Control Design
- GPS based Data-Logging
- Wi-Fi Connectivity
- CANBUS Platform
- Air & Road Temperature Sensor Ready

Controller Features

- Configurable Error Status Indicators
- Open & Short Circuit Protection and Alerts
- Current Compensated, Pulse Width Modulated Outputs
- System Sources Current to Valve Coils
- Upgradeable Software
- Data Downloading through Wi-Fi & USB Drive
- Real-time Wi-Fi Support Line
- AVL System Ready
- Ground Speed Orientation
- Programmable Body Configurations
- Open/Closed Loop Spreader & Liquid Operation
- Expandable I/O

CONTROLLER OPERATION

CONTROLLER NAVIGATION:

Cycle Screens: Depress the Auger or Spinner to cycle screens.

Adjustments: Tap the appropriate touch screen button to change settings. Hydraulic performance settings can be adjusted in the configuration menu.

Operation: Use the appropriate buttons and rotary knobs to control the spreader operation.

BUTTON ASSIGNMENTS:

Spreader: Press to initiate the spreader system.

Blast: Press to “Blast” or increase the granular rate to a configurable set point for an adjustable time.

Pause: Press to pause or un-pause all spreader operations.

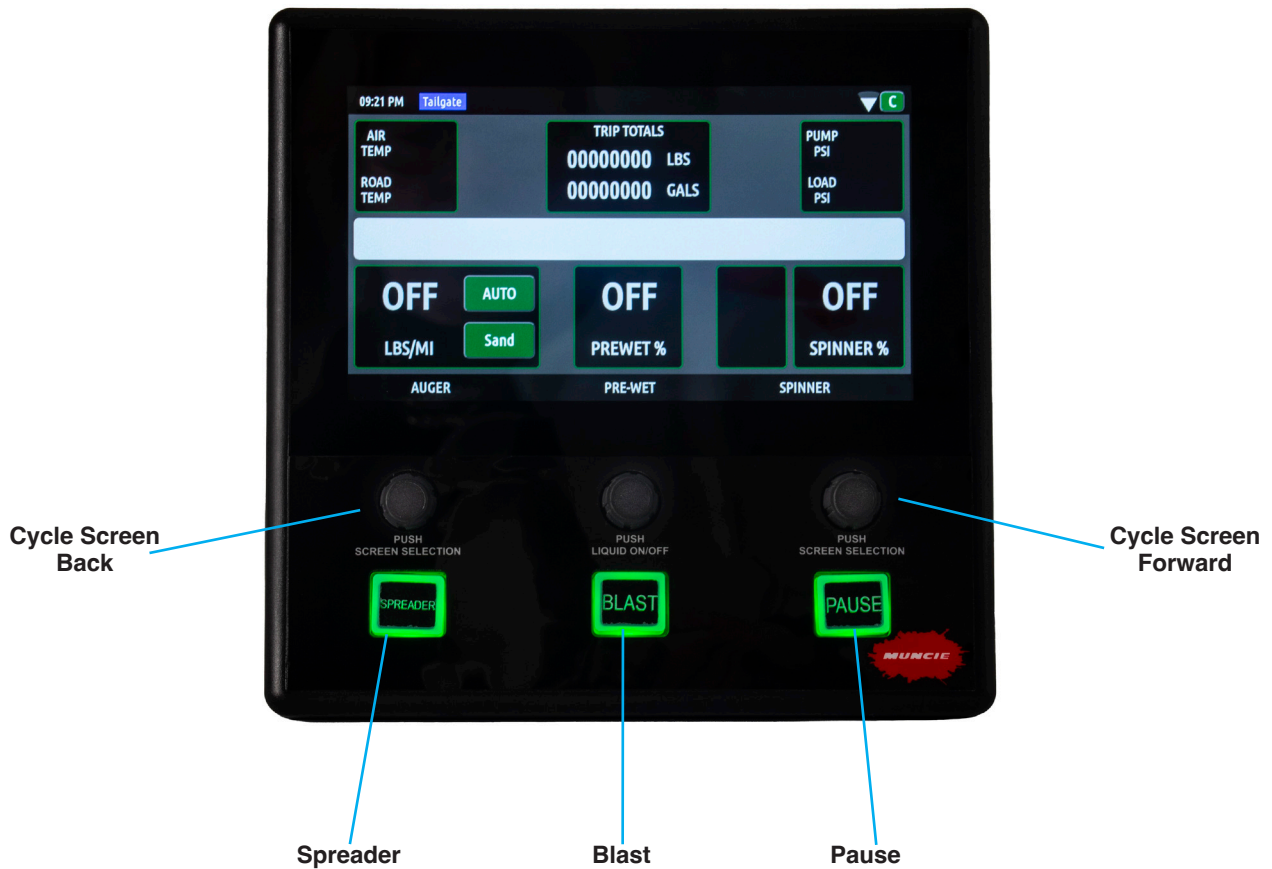

CONTROLLER OPERATION

Body Selection & Diagnostic Connection:

This following screen should be referenced before any operation to ensure the “Body” selection type is correct for the given body that is currently being operated. Selecting the wrong body type could result in unintended machine operation.

Body Selection – Depress the Body Selection button to sequence through different body configuration. **Note: Available body type discussed later in the document and are preconfigured by Muncie Technicians before system ships.** Alternate body configurations can be added by contacting the Muncie Power Products Snow and Ice team.

Diagnostic Connection – This feature allows the user to connect to Muncie for diagnostic purposes. Simply connect to a Wi-Fi network and press the Start button to connect to Muncie for Diagnostic help.

Remote Connection Status – Displays the current state of the wireless connectivity (Muncie Use Only).

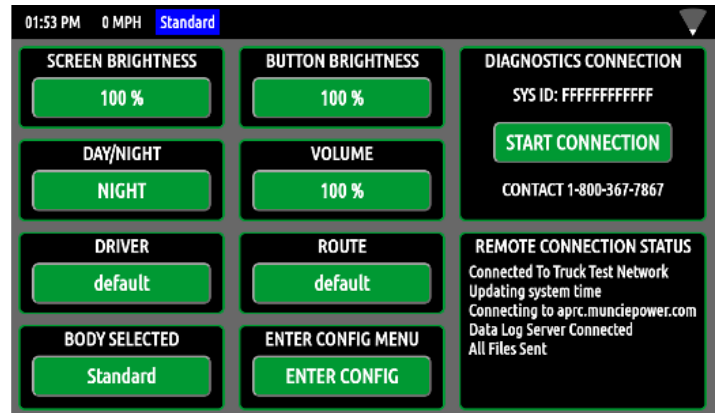

CONTROLLER OPERATION

Main Operating Screen – Standard Spreader Body:

Air Temp/Road Temp – Displays air and road temperatures. Temperatures will only display if IR temperature sensor is installed.

Trip Totals – Displays the material and liquid totals per trip. Simply tap to reset. Keep in mind that resetting these totals doesn't reset the spreader datalog.

Joystick Mode – Displays the current piece of equipment the joystick is controlling.

Wi-Fi Strength – Displays the Wi-Fi signal strength.

System Pressures/Oil Temperature – Toggle this selection to alternate between system pressures and oil temperature.

Message Bar – Displays error messages.

Spinner Rate – Displays the spinner rate as a percent or lane coverage.

Pre-Wet Rate – Displays the pre-wet rate.

Product Type – Displays the material being spread. Tap to change products available.

Auger Rate – Displays the auger rate. In manual mode, the setting is displayed as a percentage. In auto mode the rate is displayed as Lbs/Mile. Keep in mind that this value will remain constant, but the material discharged will vary per vehicle speed to maintain a constant output per mile.

Mode – Displays the mode of operation. Toggle button to change between Auto and Manual.

Hot Buttons – Buttons can be configured on the touchscreen for additional system functionality.

Time – Displays the current time.

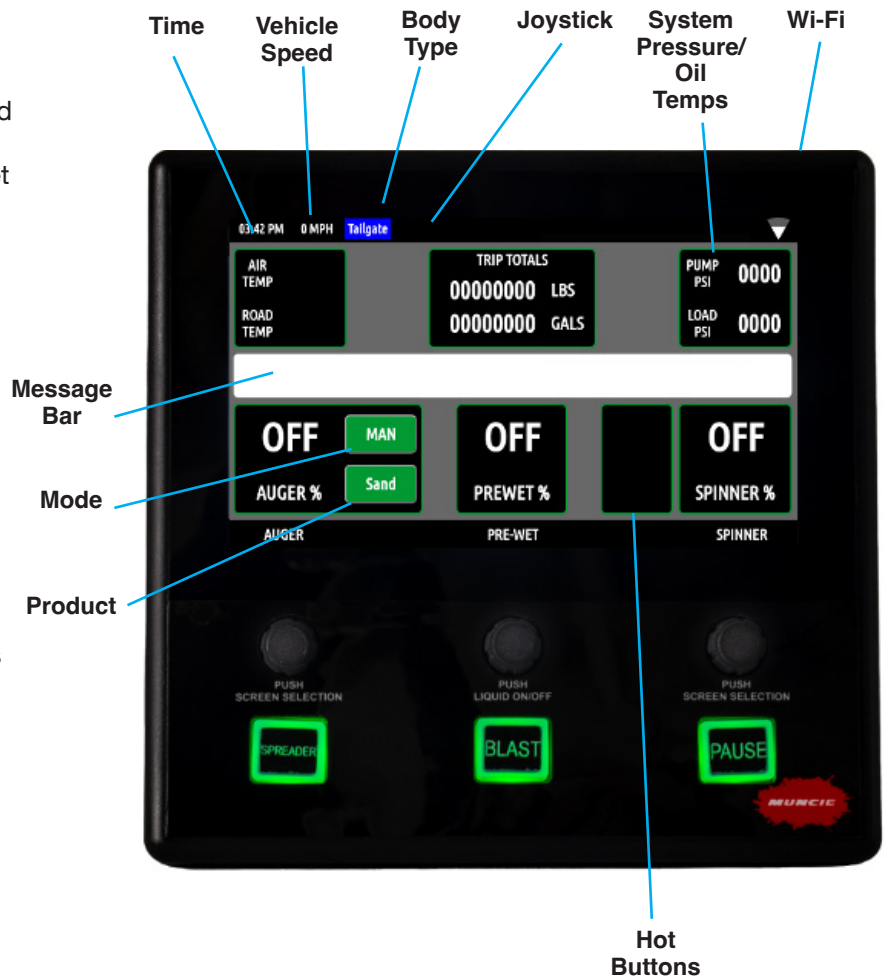

MAIN OPERATING SCREENS

Main Operating Screen – Anti Ice:

Air Temp/Road Temp – Displays air and road temperatures. Temperatures will only display if IR temperature sensor is installed.

Joystick Mode – Displays the current piece of equipment the joystick is controlling.

System Pressures/Oil Temperature – Toggle this selection to alternate between system pressures and oil temperature.

Message Bar – Displays error messages.

Liquid Rate – Displays the liquid rate. Use the auger rate knob to control the speed of the liquid output.

Mode – Displays the mode of operation. Toggle button to change between Auto and Manual.

Boom Controls – Up to 3 booms can be configured with the system. Booms can either be controlled with on screen touch buttons or switch controls. Press appropriate boom controls to actuate. When a boom is actuated, the button will latch orange to indicate that it is “on”.

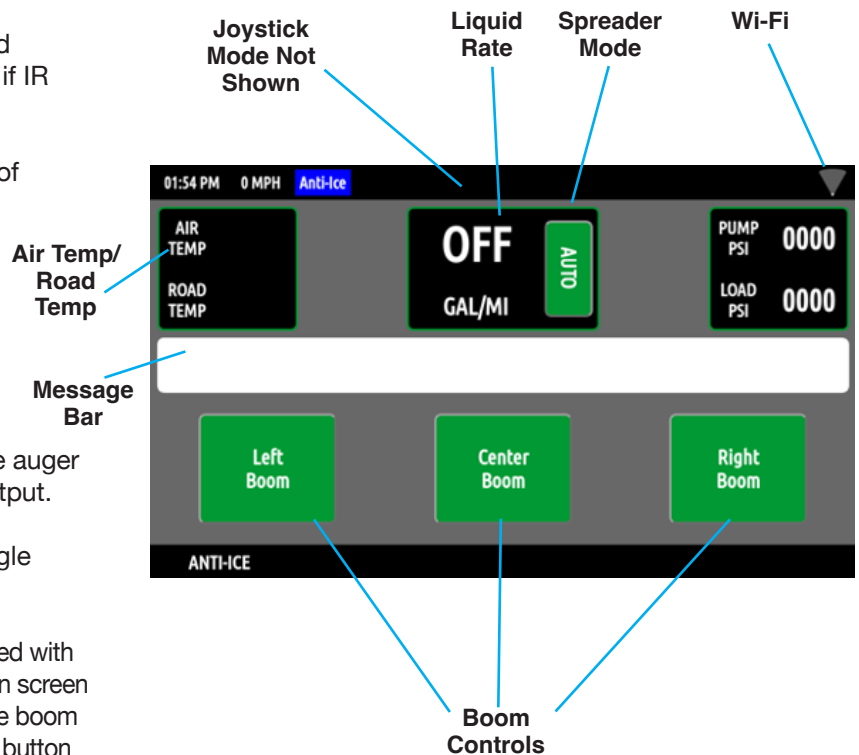

Main Operating Screen – Tow Plow:

Air Temp / Road Temp – Displays air and road temperatures. Temperatures will only display if IR temperature sensor is installed.

Joystick Mode – Displays the current piece of equipment the joystick is controlling.

System Pressures / Oil Temperature – Toggle this selection to alternate between system pressures and oil temperature.

Message Bar – Displays error messages.

Auger Rate – Displays the auger rate. In manual mode, the setting is displayed as a percentage. In auto mode the rate is displayed as Lbs/Mile.

Auger #2 Rate – Displays the auger rate for the tow plow. In manual mode, the setting is displayed as a percentage. In auto mode the rate is displayed as Lbs/Mile.

Spinner Rate – Displays the spinner rate as a percent or lane coverage.

Mode – Displays the mode of operation. Toggle button to change between Auto and Manual.



MAIN OPERATING SCREENS

Main Operating Screen – Directional Body:

Air Temp/Road Temp – Displays air and road temperatures. Temperatures will only display if IR temperature sensor is installed.

Trip Totals – Displays the material and liquid totals per trip. Simply tap to reset. Keep in mind that resetting these totals doesn't reset the spreader datalog.

Joystick Mode – Displays the current piece of equipment the joystick is controlling.

System Pressures/Oil Temperature – Toggle this selection to alternate between system pressures and oil temperature.

Message Bar – Displays error messages.

Product Type – Displays the material being spread. Tap to change products.

Liquid Rate – Displays the liquid rate. Use the auger rate knob to control the speed of the liquid output.

Mode – Displays the mode of operation. Toggle button to change between Auto and Manual

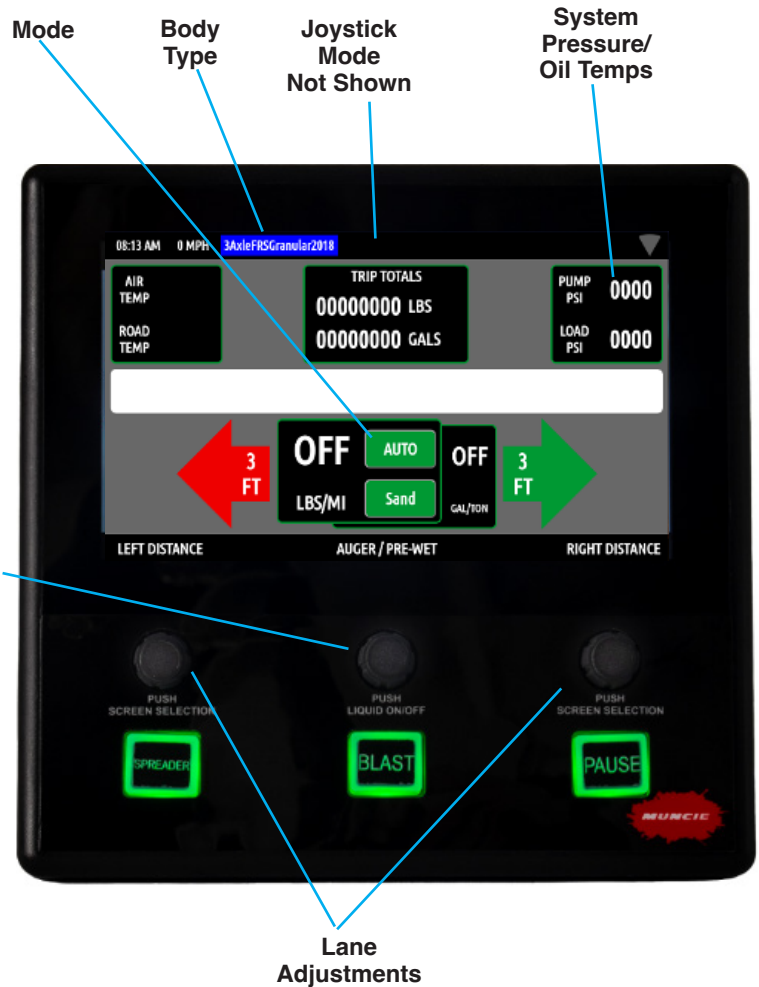

Main Operating Screen – Spray Body:

Trip Totals – Displays the material and liquid total per trip. Simply tap to reset. Keep in mind that resetting these totals doesn't reset the spreader dialog.

System Pressures/Oil Temperature – Toggle this selection to alternate between system pressures and oil temperature.

Message Bar – Displays error messages.

Liquid Rate – Displays the liquid rate

Mode – Displays the mod of operation. Toggle button to change between Auto and Manual.

Boom Controls – Up to 3 booms can be configured with the system. Booms can either be controlled with on screen touch buttons or switch controls. Press appropriate boom controls to actuate. When a boom is actuated, the button will latch orange to indicate that it is "On".



MAIN OPERATING SCREENS

Main Operating Screen – External Equipment Body:

Air Temp/Road Temp – Displays air and road temperatures. Temperatures will only display if IR temperature sensor is installed.

Trip Totals – Unused for this mode. The system is simply turning flow on and off to designated output.

System Pressures/Oil Temperature – Toggle this selection to alternate between system pressures and oil temperature.

Message Bar – Displays error messages.

External Equipment – Displays the “Off” or “On” status for the hydraulic flow to External Equipment.

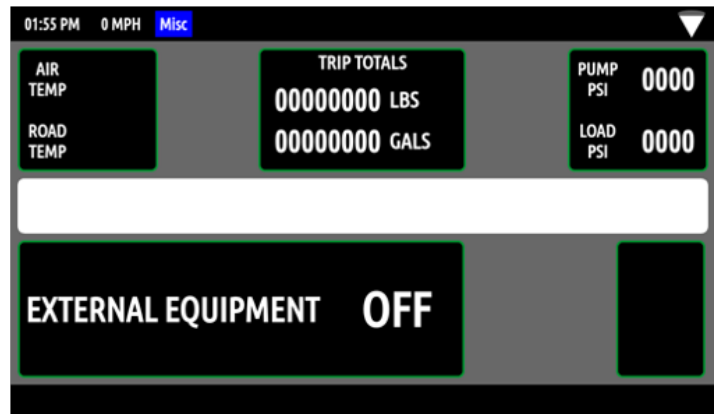

Main Operating Screen – Uncontrolled Body:

Air Temp/Road Temp – Displays air and road temperatures. Temperatures will only display if IR temperature sensor is installed.

Trip Totals – Unused for this mode. No spreader functions available in this mode.

System Pressures/Oil Temperature – Toggle this selection to alternate between system pressures and oil temperature.

Message Bar – Displays error messages.

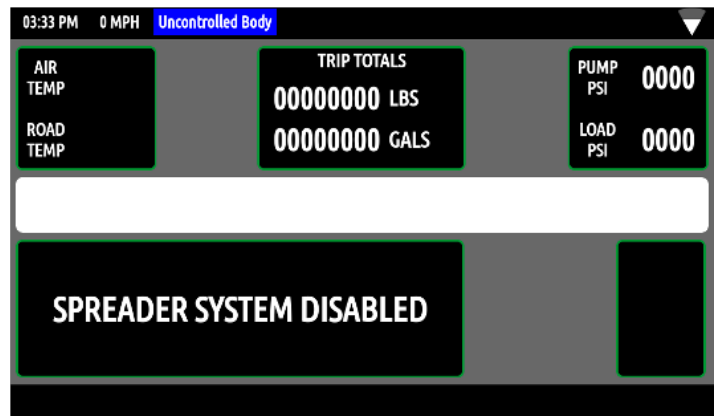

OPERATOR SCREEN ADJUSTMENTS

Day/Night - The controller has two configurable brightness settings for day and night modes. Select the mode and adjust the screen and button brightness as desired. Controller will automatically change from Day/Night mode at sunrise/sunset time each time. Pressing this button will swap modes and can be used to override this setting.

Screen Brightness – Select to adjust the screen brightness.

Button Brightness – Select to adjust the button brightness.

Volume – Select to adjust the volume of the controller.

Driver – Toggle to select the pre-configured operator.

Route – Toggle to select the pre-configured route.

Body Selected – Toggle to select an alternate pre-configured body modes. Additional body configurations can be added by contacting the Muncie Power Products Snow and Ice Team.

Enter Config Menu – Select this setting to enter the configuration menu. Reference page 5 to access the configuration menu and make system adjustments. This menu is password protected to limit access to unauthorized personnel.

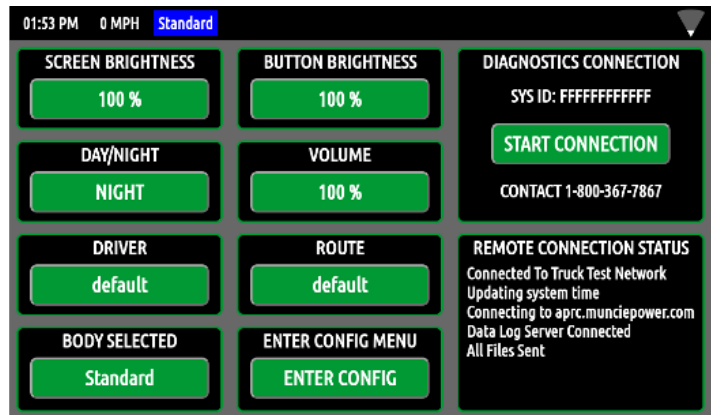

Remote Connection Status – Displays the current state of the wireless connectivity (Muncie Use Only).

Diagnostic Connection – This feature allows the user to connect to Muncie for diagnostic purposes. Simply connect to a Wi-Fi network and press the Start button to connect to Muncie for Diagnostic help.

MAIN OPERATING ADJUSTMENTS

Granular Totals – Displays the total granular materials by product, discharged since log last cleared.

Totals – Displays the total amount of deicing and Pre-wetting products discharged since last log cleared.

Truck ID – Displays the pre-configured user ID, which is utilized for fleet-wide data logging purposes.

Averages – Displays the average discharge rates of de-icing products and average vehicle speed.

System – Shows real-time status of vehicle speed, liquid tank level, current runtime and total runtime.

Diagnostics – Shows real-time status of hydraulic pressures, oil temperature (if applicable), and oil level (if applicable).

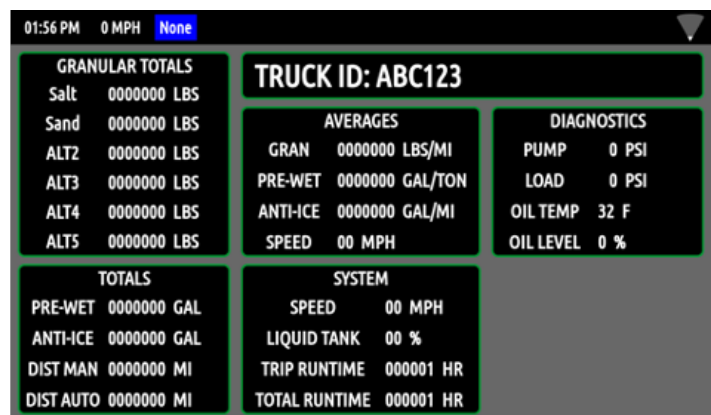

OPERATOR SCREEN ADJUSTMENTS

Accessing Configuration Menu:

This menu is passcode protected to limit access to non-authorized personnel. It is recommended to change the passcode from the default value to limit access and prevent unintentional system adjustments.

Follow the steps below to enter the configuration menu:

1. Using the touchscreen, press the “ENTER CONFIG” BUTTON. This should prompt a keyboard to appear.
2. Using the onscreen keyboard, enter the passcode and press the return button at the bottom right of the screen.

(Default Passcode = 1)



CONFIGURATION MENU

Configuration Menu – Navigation:

Screen Navigation – Depress the auger and spinner knobs to cycle through the configuration menu screens.

Quick Access Bar – Utilize the quick access bar on the left side of the screen to directly access certain configuration screens.

Configuration Menu – System Information:

Truck ID – To change, select the truck ID box. The truck ID allows the user to keep the datalog information separate between the trucks.

Flash Drive Status – Displays the status of the flash drive. To connect, simply insert a USB flash drive in the USB port. The flash drive should auto connect. If not, press the “CONNECT USB” button. To disconnect, press the “DISCONNECT USB” button.

Firmware Update: if instructed by Muncie, connect flash drive with the appropriate firmware files and press the “UPDATE FIRMWARE” button.

System Sync: In the event a new module is replaced in the system, press the “system sync” button to manually resend the appropriate settings to the new module.

System Versions: Displays the current version of firmware installed on the system (Muncie Use Only).

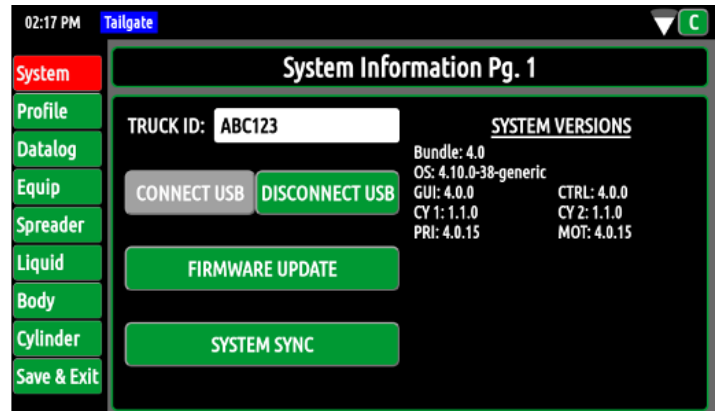

CONFIGURATION MENU

Configuration Menu – System Profile:

Truck Profile Number – The profile contains all of the unique calibration settings, button mapping, and I/O configurations of the system. The user is able to download this file (system profile) and load to identical systems within a fleet to mirror settings.

Load Profile – The “LOAD PROFILE” button allows the user to transfer the system profile from the flash drive to the spreader controller (i.e. upload).

Save Profile – The “SAVE PROFILE” button allows the user to transfer the system profile from the controller to the flash drive. (i.e. download)

Flash Drive Status – Displays the status of the flash drive. To connect, simply insert a USB flash drive in the USB port. The flash drive should auto connect. If not, press the “CONNECT USB” button. To disconnect, press the “DISCONNECT USB” button.

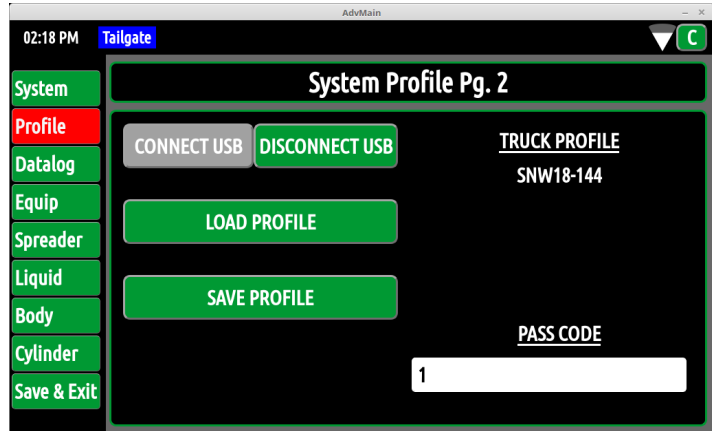

CONFIGURATION MENU

Configuration Menu – Connecting to Wi-Fi:

View Networks/View Config – Toggle this button to switch between connected Wi-Fi networks vs. available networks.

Available Networks – To connect to an available network, click on the view networks button and select the preferred Wi-Fi network and enter the appropriate credentials.

Manually Add Network – If the network is unavailable or hidden, the user may manually connect.

1. Click [Add Network] on the Wi-Fi configuration screen and populate the appropriate fields.
2. If network is hidden, select this option on the network credentials page.
3. Push “UPDATE” to Save Entry and Connect.

Connected Networks – On the View Config page under the “ADD Network” button the current list of connected networks will be displayed.

Remove Network – To remove a network click “DELETE” button next to the network you wish to delete.

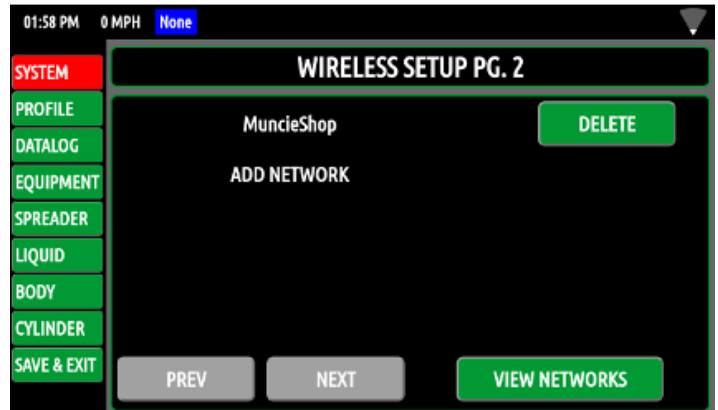
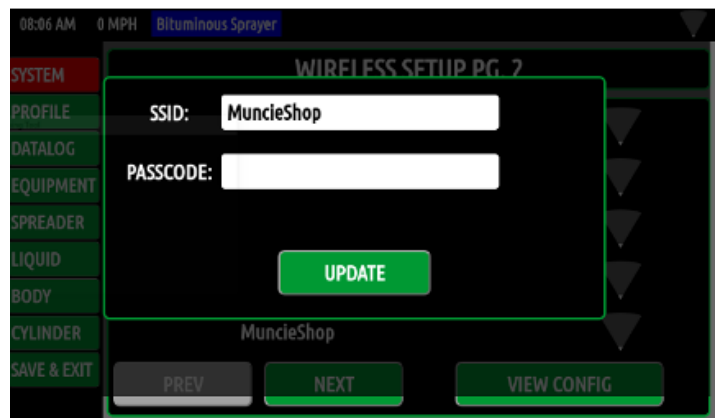
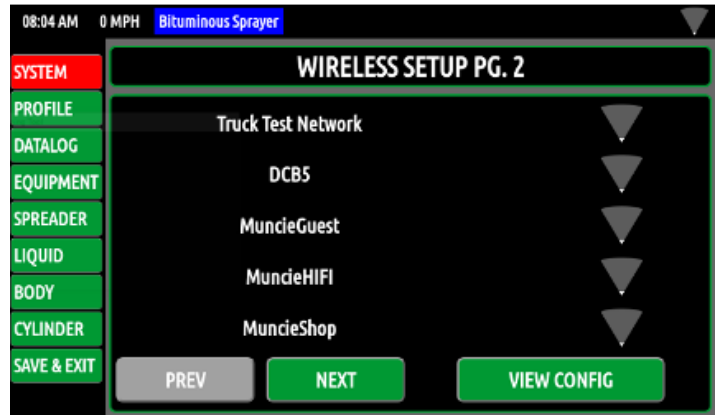

CONFIGURATION MENU

Configuration Menu – Datalogging:

Flash Drive Status – Displays the status of the flash drive. To connect, simply insert a USB flash drive in the USB port. The flash drive should auto connect. If not, press the “Connect USB” button. To disconnect, press “Disconnect USB” button.

Transfer Logs to USB – Press the “TRANSFER LOGS TO USB” to download datalog files to flash drive.

Clear Logs – Press the “CLEAR LOGS” button to delete the stored datalog files.

Date/Time Synchronization

- **Manually Set Date/Time** – Press the “Sync to GPS” button to change it to manually set. This will allow the “Set DATE/TIME” button to be used to manually set the time and date.
- **Auto Set Date/Time** – When set to Sync to GPS it will automatically get time and date from GPS receiver.

Time Zone Synchronization – When set to Sync to GPS the time zone will be found using the onboard GPS. Pressing this button will change the system to allow for manual entry of the time zone.

Configuration Menu – Datalogging:

Time Interval – Toggle to set how often the system records data points. Available settings are 10, 30, 60, 90, and 120 seconds.

Log Clear – The Log clear selection allows the user to set when the datalog is cleared.

- AUTO – clears the datalog after downloading.
- DAILY – clears the datalog once a day.
- NEVER – allows the controller to continue recording unless manually cleared through the configuration menu.

Log E-Mail – Insert the email address to auto send/ email log files. Keep in mind the controller will need to be connected to a Wi-Fi signal to send these files.

The datalog files are sent out 10 times a day in two hour intervals. Any log files with the same email address will be sent at the same time. Files will come from noreply@munciepower.com This is an unmonitored address, so do not send email replies to it.

To download the files from an email, right click the attachment and select the “save as” option and save the file to the desired location.

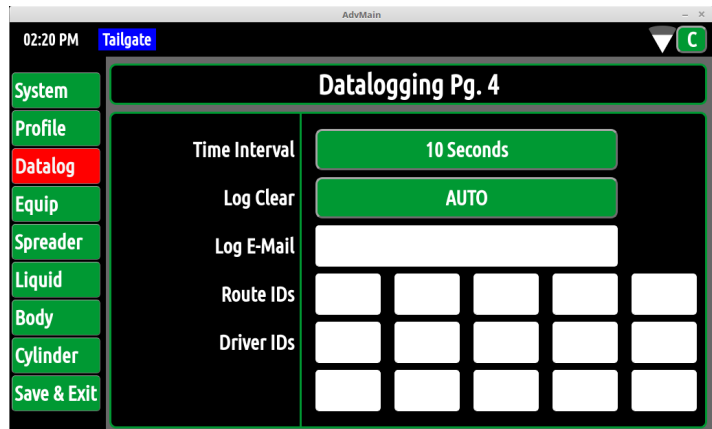
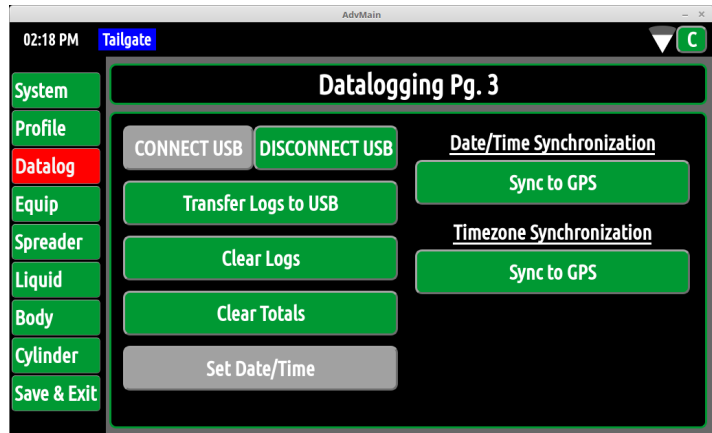

Route ID's – Press each white box to enter the Route ID. The correct route ID must be selected in the operations screen. The datalogs will now show the route ID.

Driver ID's – Press each white box to enter the operator initials. The correct operator ID's will now be selectable from the operation menu and show in the datalogs.

CONFIGURATION MENU

Global Equipment Settings:

Pump Type – Toggle the pump type button to select gear, piston, or disabled. Disabled is utilized for piston pumps, but the valve network is not equipped with an electrically controlled main relief.

Main Relief Press – Select to adjust the Main Relief Pressure. The system can be set to a maximum of 3,000 PSI. Deadhead the plow angle to observe the main relief pressure.

Current Pressures – This text indicates the pump pressure and load sense pressure being transmitted from the pressure transducers located at the valve assembly.

Groundspeed Cal:

Option 1 – The ground speed can be set two different methods. First, if the pulses per mile are known for the chassis, simply input the value in the “Groundspeed Cal” box.

Option 2 – Or, drive the truck and maintain 20 MPH while pressing the “Calibrate” button. This will auto populate the “Groundspeed Cal” text box.

Groundspeed Warning – Press the button to enable this feature. This will bring up a pop-up window that can be used to adjust the groundspeed warning from 0-60 MPH. When the selected speed is exceeded a message will display in the message box informing the driver to slow down.

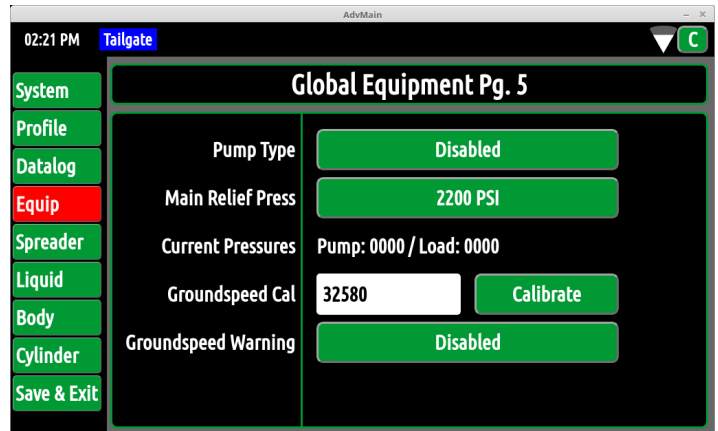

CONFIGURATION MENU

Global Equipment Settings:

Air/Road Temp – This text displays the current state temperature being reported from the air/road temp sensor.

Road Temp Offset – This adjustment allows the road temperature to be tuned if the current reading is slightly inaccurate.

1. To check the accuracy of the road temperature, insert a cup of ice water under the IR sensor. The temperature should read approximately 32° F.

2. If the temperature is off, select the text box to offset the temperature as needed.

* The air temperature cannot be adjusted. Keep in mind that the air temperature can be slower to adjust since it is a function of the sensor housing.

Air Temp Alert – This adjustment allows the configuration of an alert associated with exceeding the desired temperature threshold.

Road Temp Alert – This adjustment allows the configuration of an alert associated with exceeding the desired temperature threshold.

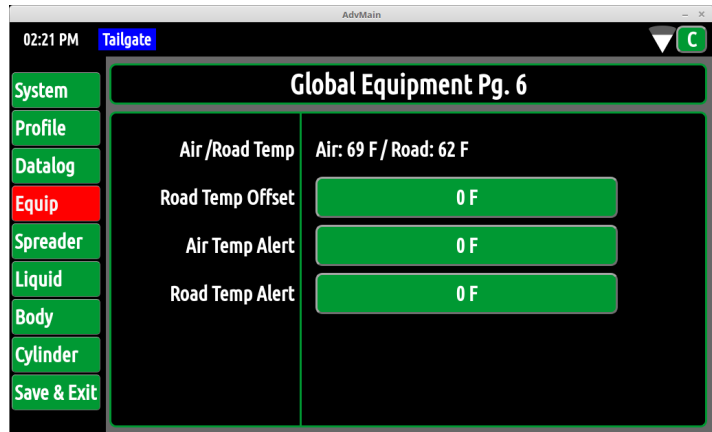

CONFIGURATION MENU

Global Equipment Settings:

Retain Settings – The retain settings button allows the system to retain the Auger, Liquid, and Spinner rates through power cycles.

Caution: This will cause the spreader controller to retain the settings after the controller has been powered off. Be aware that simply pressing the “Spreader” button will automatically re-engage the motors at their previous settings.

Manual Mode Lockout – Manual mode can be enabled or disabled by toggling this button. Disabling manual mode will prevent the operator from accessing this mode above 7 MPH graying out the option to switch modes. When under 7 MPH access to the manual mode to allow material to be offloaded.

0 MPH Spinner – The 0 MPH spinner feature allows the spinner operation to halt when the truck comes to a stop. If the setting is configured for “spinner on” the spinner will remain spinning regardless of truck speed.

Blast Level – The blast level sets the auger speed when the blast button is pressed. This is adjustable from 50-100%.

Blast Duration – The blast duration can be adjusted from 1-254 seconds. When below 1 second, the blast duration will display momentary and will only stay on when the blast button is held. When above 254 seconds, the blast will display “Latch” and will keep the blast on indefinitely.

Take-off Timer – The Take-off Timer is adjustable from 0.5 seconds. Turning this setting above 0 will cause the auger to blast material or liquid for the set increment of time after the truck has accelerated from a stop.

Global Spreader Settings:

Main Product Name – The Main Product Name allows the user to change the text for the primary spreader material. Select box to change.

Lane Width – This calibrates the controller to the correct lane width for the spinner. This is only relevant when the directional spinner mode is active.

Directional Mode – When engaged, this allows the controller to spread material in feet or lanes.

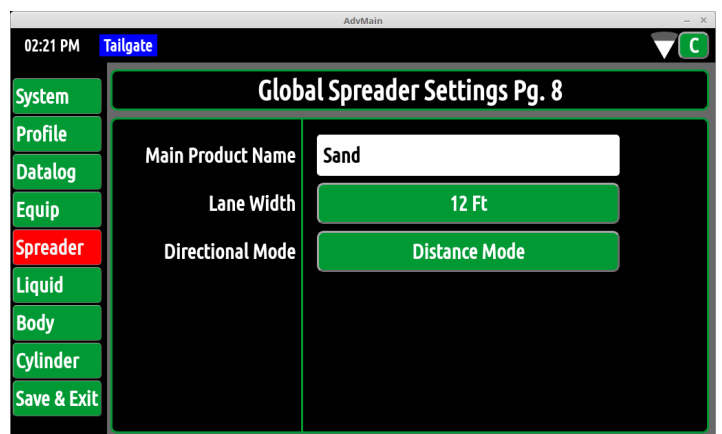
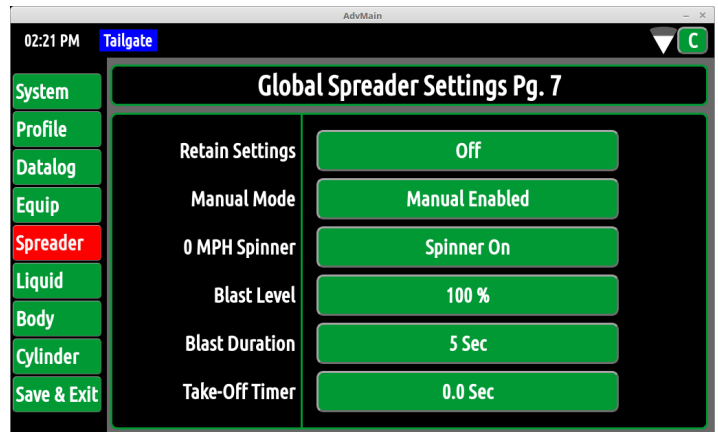

CONFIGURATION MENU

Granular Setpoints:

Granular Mode – Two operating modes are available:

Setpoint – If “Setpoint Mode” is selected, the user has the ability to dial in the exact auto mode settings available to the operator. Up to six rates are available to pre-configure.

Range – If range is selected, the user has the ability to set the low and high rates available for auto mode.

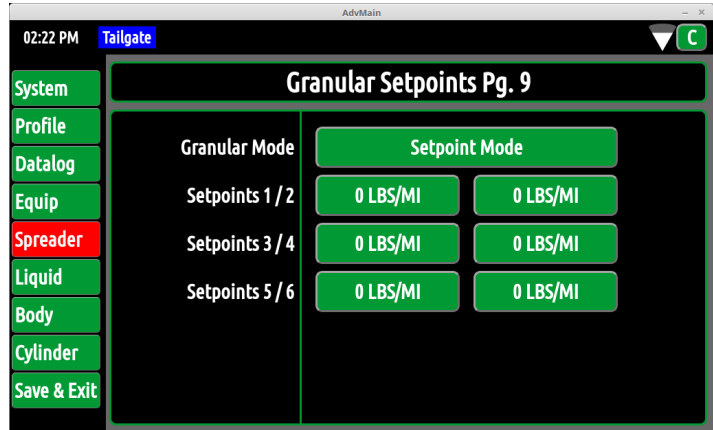

Granular Products:

Product Names – Select the white boxes to change the alternate product names.

Granular Ratios – If multiple products are used, setting product ratios will increase the accuracy of the material spread. For example, if the user spreads sand as an alternate product, he could input the material name in the Alt 1 Box. In addition, he could input the product weight ratio to increase the accuracy of the material output discharged.

To calculate the ratio: Take a 5 gallon bucket of the alternate product and divide by a 5 gallon bucket of salt. (52 lbs./45 lbs.) – 1.15 or 115%.

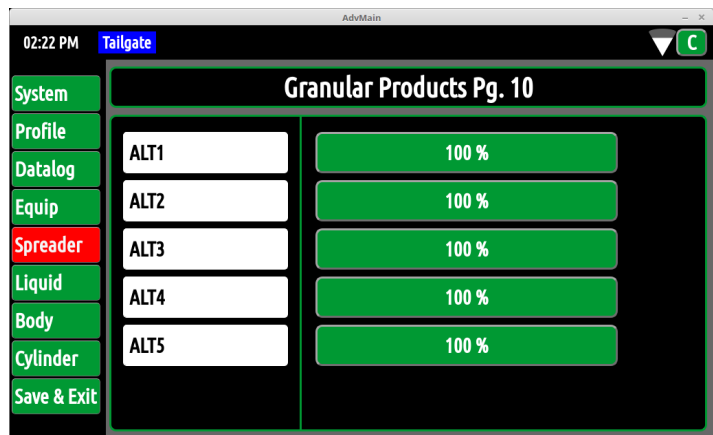

Anti-Ice Control Settings:

Preset Mode – The user can select two types of Preset Modes:

Set Point Mode – If setpoint is selected, the user has the ability to dial in the specific settings available. Up to three anti-ice rates are available in this mode.

Range Mode: If range is selected, the user has the ability to set the low and high auto rates. This gives the operator a range of settings in gallons per mile.

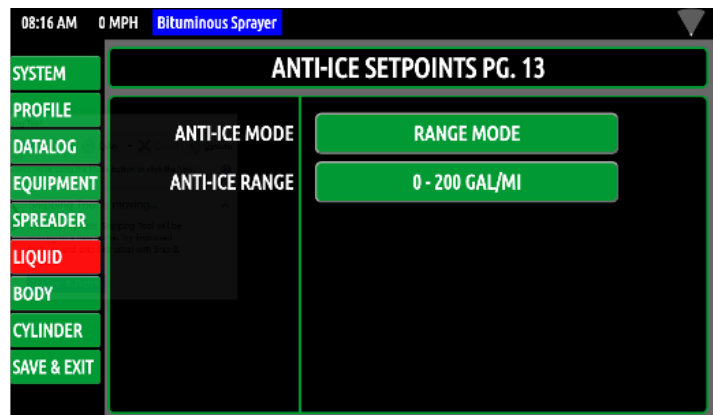

CONFIGURATION MENU

Body Selections:

Current Body – Select the specific body type to access and adjust the tailored calibration settings. These body types are configured by a Muncie Technician before the system is shipped. If an alternate body type is needed please contact Muncie Power Products to have it added to the system profile.

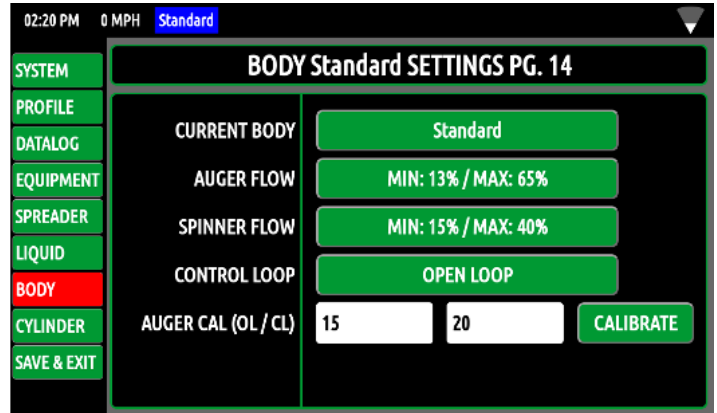

Standard Body Settings:

Current Body – This setting indicates the pre-configured body types available. By toggling this setting, the configuration screens are reconfigured to custom calibrate each specific body type.

Auger Flow – Select the Auger Flow “Min/Max” button to adjust the speeds. The Min setting needs to be adjusted so that the auger is barely turning at this setpoint. The Max setting is the maximum preferred auger speed.

Spinner Flow – Select the spinner flow “Min/Max” button to adjust the speeds. The Min setting should be adjusted so that the spinner is barely turning at this setpoint. The Max setting is the maximum preferred spinner speed.

Control Loop – The closed loop can be adjusted from open loop to closed loop by pressing the button. Closed loop requires that the auger has a feedback sensor installed. Open loop doesn't require a feedback sensor.

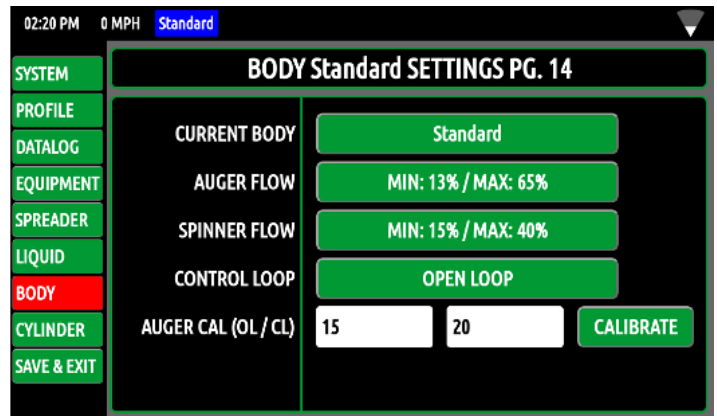

Auger Cal (OL/CL) – If the open loop calibration value or closed loop pulse count is known, this can be directly entered into the appropriate text box. If these values are unknown, a weighed dump calibration process should be performed for accuracy. Press the calibrate button to begin process.

CONFIGURATION MENU

Auger Calibration Process:

Purpose – The spreader calibration is recommended for auto mode accuracy. It allows the controller to accurately discharge material at the rate shown and accurately log how much material is discharged.

1. Load the spreader with the primary material and weigh the truck. Before beginning the unloading process, increase and hold the engine at 1,000 RPM.
2. Press the “Calibrate” button to begin the spreader calibration process.
3. A popup will appear once the calibration occurs. Use the up and down buttons to select a drive current. We recommend setting this between the min and max auger settings for best accuracy. Press continue to proceed with the process.
4. Allow the spreader to unload for 5-7 minutes. During the unloading process, hit “Stop” to pause and “resume” to continue offloading process.
5. When the offloading process is complete:
 - a. Press the “Stop” button.
 - b. Reweigh the truck and calculate the amount of material dumped.
 - c. Use the up and down button to enter the weight of material dumped.
 - d. Press the “Save” button.

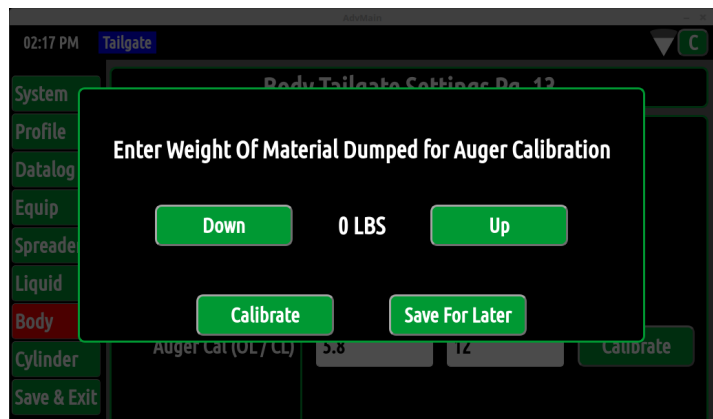
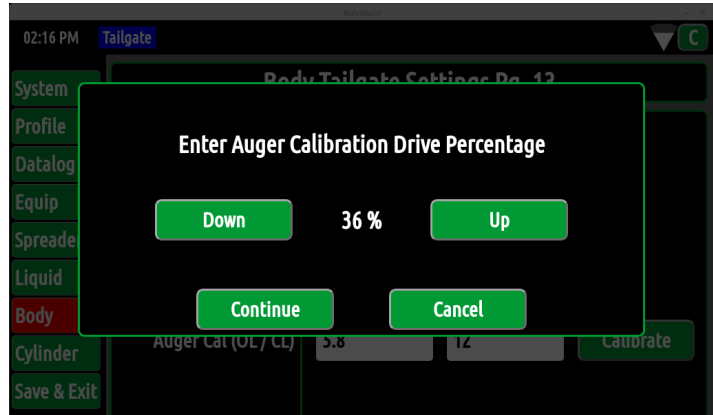

Standard Body Pre-Wet Settings:

These settings are specific to the current body selected. If multiple bodies are configured each can have its own Pre-Wet settings.

Pre-Wet Flow – Select the button to adjust the min and max pre-wet speeds. Next, toggle the up and down buttons to adjust the settings.

Pre-wet Control Loop – The “Control Loop” can be adjusted from open to closed loop by pressing the button. Closed loop requires a feedback sensor (flow turbine).

Pre-Wet Cal (OL/CL) – Open Loop Calibration Value – The open loop pre-wet calibration is displayed in this box. This value is automatically generate when a calibration is performed. This value can be input into identical setups to prevent having to perform multiple calibrations.

Pre-Wet Calibrate – Performing a pre-wet calibration increases the accuracy of the pre-wet output.

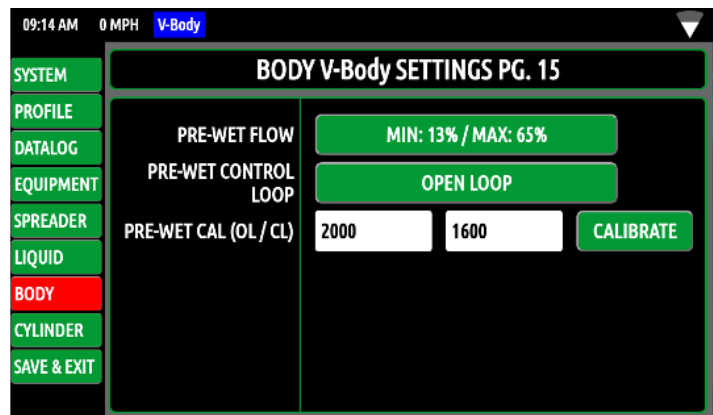

CONFIGURATION MENU

Pre-Wet Calibration Process:

Pre-Wet Cal – Performing a pre-wet calibration increases the accuracy of the pre-wet output.

1. Place a 5 gallon bucket or other know volume container under the pre-wet nozzle.
2. Press the “Calibrate Button” to initiate the process.
3. Use the up and down buttons to select a drive current. We recommend setting this between the min and max pre-wet settings for best accuracy.

Press Start to begin the calibration process.

4. Allow the pre-wet to spray until the 5 gallon bucket is full. If required to pause operation, hit “Stop” to pause and “Resume” to continue operation.
5. When 5 gallon bucket is full:
 - a. Press the “Stop” button.
 - b. Use the up and down buttons to enter 5 gallons.
 - c. Press the “Save” button.

Body – Anti-Ice Settings:

Anti-Ice Flow – Select the Anti-Ice Flow “Min/Max” button to adjust the speeds. The Min setting needs to be adjusted so that the anti-ice system is barely outputting liquid. The Max setting is the maximum preferred anti-ice output available to the operator.

Control Loop – The closed loop can be adjusted from open loop to closed loop by pressing the button. Closed loop requires that the anti-ice has a feedback sensor installed. Open loop doesn’t require a feedback sensor.

Anti-Ice (OL/CL) – If the open loop calibration value or closed loop pulse count is known, this can be directly entered into the appropriate text box. If these values are unknown, a calibration process will need to occur.

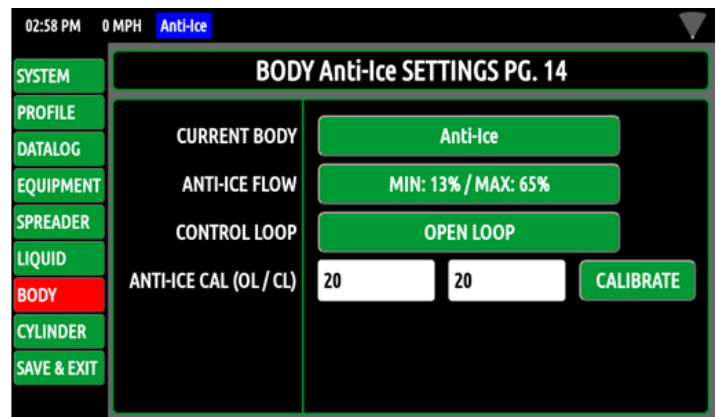

CONFIGURATION MENU

Directional Bodies:

Auger Flow – Select the Auger Flow “Min/Max” button to adjust the speeds. The Min setting needs to be adjusted so that the auger is barely turning at this setpoint. The Max setting is the maximum preferred auger speed.

Spinner Flow – Select the spinner flow “Min/Max” button to adjust the speeds. The Min setting should be adjusted so that the spinner is barely turning at this setpoint. The Max setting is the maximum preferred spinner speed.

Closed Loop – The closed loop can be adjusted from open loop to closed loop by pressing the button. Closed loop requires that the auger has a feedback sensor installed. Open loop doesn't require a feedback sensor.

Auger Cal (OL/CL) – If the open loop calibration value or closed loop pulse count is known, this can be directly entered into the appropriate text box. If these values are unknown, a weighed dump calibration process should be performed for accuracy. Press the calibrate button to begin process.

Max Spinner Dist – Max Spinner Distance can be set to the max overall distance the user wants the operator to be able to spread material.

09:45 AM 0 MPH 2AxleFSHGranular2019

BODY 2AxleFSHGranular2019 SETTINGS PG. 14

SYSTEM	CURRENT BODY	2AxleFSHGranular2019		
PROFILE	AUGER FLOW	MIN: 13% / MAX: 65%		
DATALOG	SPINNER FLOW	MIN: 13% / MAX: 40%		
EQUIPMENT	CONTROL LOOP	CLOSED LOOP		
SPREADER	AUGER CAL (OL / CL)	15	40	CALIBRATE
LIQUID	MAX SPINNER DIST	36 FT		
BODY				
CYLINDER				
SAVE & EXIT				

Directional Bodies Pre-Wet:

Spinner Height – Select the correct spinner height range for the vehicle. This setting is specific to FRS bodies.

Pre-Wet Flow – Select the button to adjust the min and max pre-wet speeds. Next, toggle the up and down buttons to adjust the settings.

Pre-Wet Control Loop – The “Control Loop” can be adjusted from open to closed loop by pressing the button. Closed loop requires a feedback sensor (flow turbine).

Pre-Wet Cal (OL/CL) – Calibration Value – The calibration values are displayed in this box. This value is automatically generate when a calibration is performed. This value can be input into identical setups to prevent having to perform multiple calibrations.

Liquid Ration – This value is used with Xzalt bodies to set the percentage of liquid as a ratio to the granular value. This allow the Xzalt body to operate using one set point for both granular and liquid output.

Liquid Weight – This value is used with Xzalt bodies to set the weight for 1 gallon of Pre-wetting liquid. This allows it to correctly calculate the liquid ratio for the system.

09:49 AM 0 MPH 2AxleFSHGranular2019

BODY 2AxleFSHGranular2019 SETTINGS PG. 15

SYSTEM	SPINNER HEIGHT	22-27"		
PROFILE	PRE-WET FLOW	MIN: 22% / MAX: 50%		
DATALOG	PRE-WET CONTROL LOOP	CLOSED LOOP		
EQUIPMENT	PRE-WET CAL (OL / CL)	20	7500	CALIBRATE
SPREADER				
LIQUID				
BODY				
CYLINDER				
SAVE & EXIT				

01:34 PM 0 MPH Misc

LIQUID SETTINGS PG. 12

SYSTEM	LIQUID RATIO	30 %
PROFILE	LIQUID WEIGHT	10.2
DATALOG		
EQUIPMENT		
SPREADER		
LIQUID		
BODY		
CYLINDER		
SAVE & EXIT		

CONFIGURATION MENU

Tow Plow:

Auger Flow – Select the Auger Flow “Min/Max” button to adjust the speeds. The Min setting needs to be adjusted so that the auger is barely turning at this setpoint. The Max setting is the maximum preferred auger speed.

Auger 2 Flow – Select the Auger 2 Flow “Min/Max” button to adjust the speeds. The Min setting needs to be adjusted so that the auger is barely turning at this setpoint. The Max setting is the maximum preferred auger speed. This will be the auger on the trailer portion of the tow plow.

Spinner flow – Select the spinner flow “Min/Max” button to adjust the speeds. The Min setting should be adjusted so that the spinner is barely turning at this setpoint. The Max setting is the maximum preferred spinner speed.

Control Loop – The “Control Loop” can be adjust from open to closed loop by pressing the button. Closed loop requires a feedback sensor (this setting applies to both Augers on the system).

Auger Cal (OL/CL) – If the open loop calibration value or closed loop pulse count is known, this can be directly entered into the appropriate text box. If these values are unknown, a weighed dump calibration process should be performed for accuracy. Press the calibrate button to begin process.

Auger 2 Cal (OL/CL) – If the open loop calibration value or closed loop pulse count is known, this can be directly entered into the appropriate text box. If these values are unknown, a weighed dump calibration process should be performed for accuracy. Press the calibrate button to begin process. This will be the auger on the trailer portion of the tow plow.

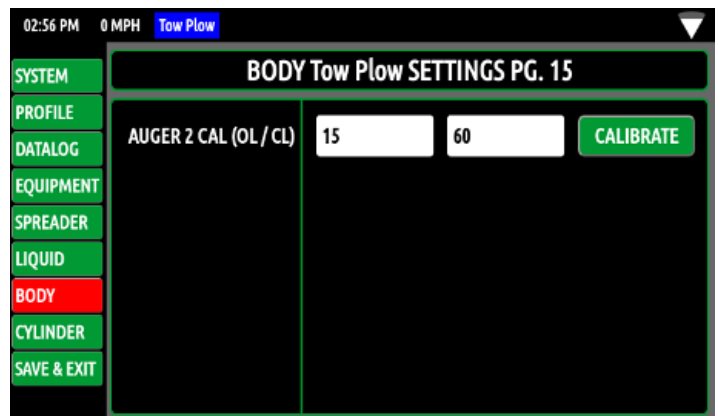
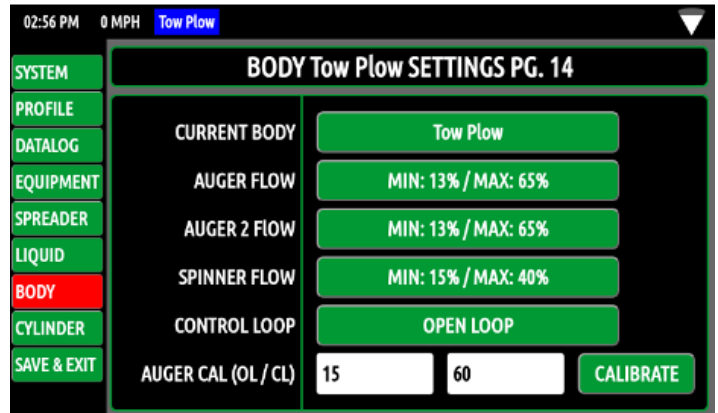

CONFIGURATION MENU

Sprayer Body:

Sprayer Flow – Select the sprayer flow “Min/Max” button to adjust the speeds. The Min setting needs to be adjusted so that the sprayer is barely outputting liquid at this setting. The Max setting is the maximum preferred sprayer speed.

Mixer Flow – Select the mixer flow “Min/Max” button to adjust the speeds. Next, toggle the up and down buttons to adjust the settings.

Sprayer Control Loop – The “Control Loop” can be adjust from open to closed loop by pressing the button. Closed loop requires a feedback sensor (flow turbine).

Sprayer Cal (OL/CL) – If the open loop calibration value or closed loop pulse count is known, this can be directly entered into the appropriate text box. If these values are unknown, a calibration process should be performed for accuracy. Press the calibrate button to begin process.

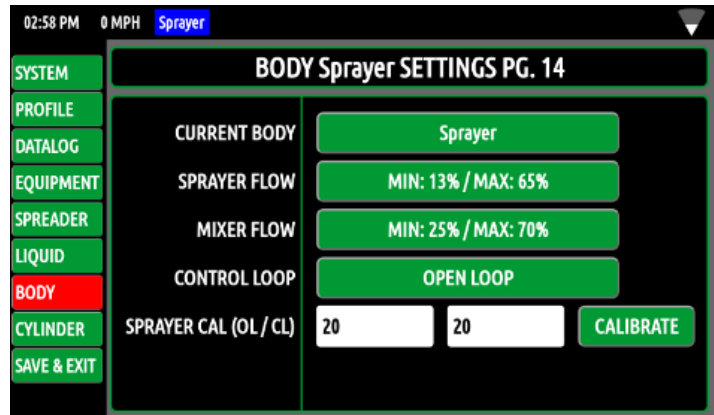

External Equipment Body:

Output Flow – Select the output flow button to adjust the percent flow/speeds routed to the External Bodies. This body type is designed to send a fixed amount of flow to an external source for use with auxiliary motor/cylinder functions not controlled by the OMNI-System Plus. Next toggle the up and down button to adjust the settings.

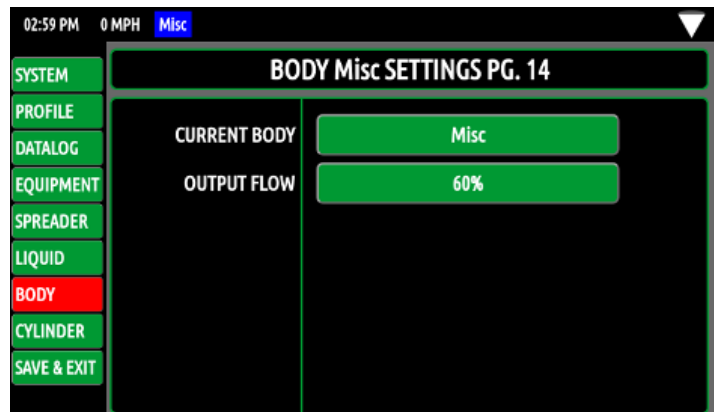

Uncontrolled Body:

This body does not have a configuration page. This particular body selection does not actuate any of the body functions.

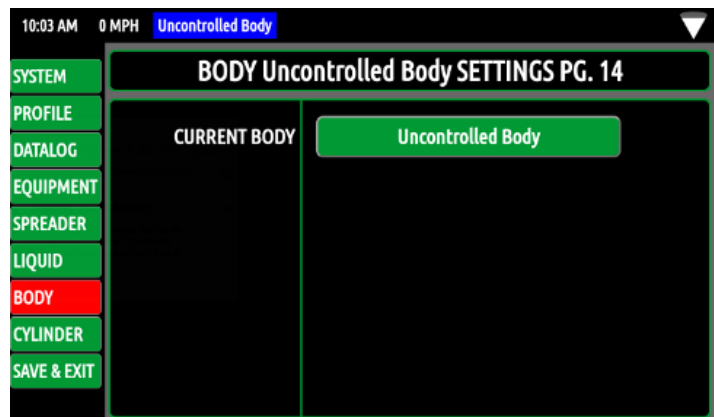

CONFIGURATION MENU

Plow Body:

Plow Down Float – This setting allows the plow float and power float to be enabled or disabled.

Plow Down Cylinder – This setting determines the cylinder type.

Plow Down Float Press – Adjust this setting when the system is equipped with power float. The more PSI selected the less pressure the plow is placing upon the road surface. Adjust the setting to help prevent excess wear on the plow edge. Be aware that setting the “Plow Down Float Press” in excess can allow the plow to fully raise from the road surface. This setting is only present if the system is configured for power float otherwise this item will be omitted.

Plow Down Relief – Adjust this setting to control the downside relief pressure. Keep in mind that the downside relief is disabled when the cylinder is set for single acting.

Plow Up Speed – Adjust this setting to control the up speed of the plow. The min% allows the deadband to be removed from the joystick operation. The max% controls the cylinder speed when the joystick is fully deflected.

Plow Down Speed – Adjust this setting to control the down speed of the plow. The min% allows the deadband to be removed from the joystick operation. The max% controls the cylinder speed when the joystick is fully deflected.

Plow Settings:

Plow Left Speed – Adjust this setting to control the left angle speed of the plow. The min% allows the deadband to be removed from the joystick operation. The max% controls the cylinder speed when the joystick is fully deflected.

Plow Right Speed – Adjust this setting to control the right angle speed of the plow. The min% allows the deadband to be removed from the joystick operation. The max% controls the cylinder speed when the joystick is fully deflected.

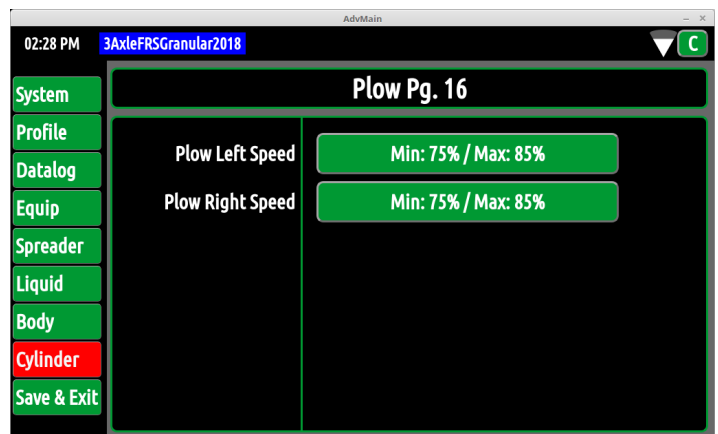
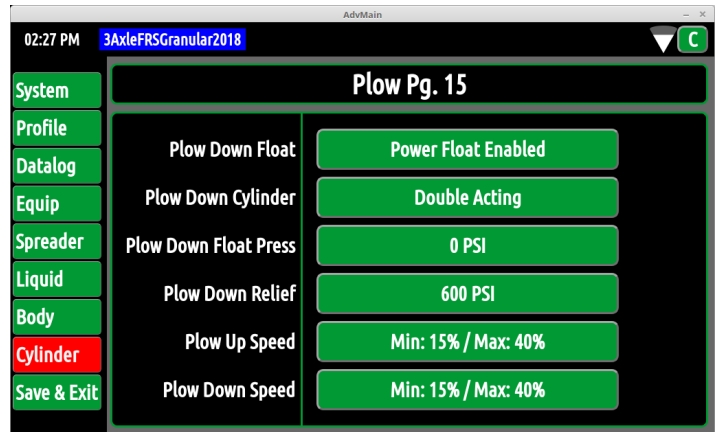

CONFIGURATION MENU

Dump Settings:

Dump Cylinder – This setting determines the cylinder type.

Dump Relief – Adjust this setting to control the downside relief pressure. Keep in mind that the downside relief is disabled when the cylinder is set for single acting.

Dump Up Speed – Adjust this setting to control the up speed of the dump cylinder. The min% allows the deadband to be removed from the joystick operation. The max% controls the cylinder speed when the joystick is fully deflected.

Dump Down Speed – Adjust this setting to control the down speed of the dump cylinder. The min% allows the deadband to be removed from the joystick operation. The max% controls the cylinder speed when the joystick is fully deflected.

Additional Settings:

Additional settings pages may be present depending on the system configuration.

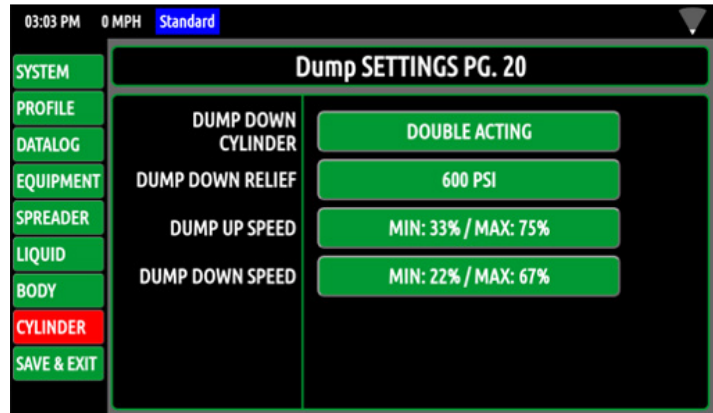

SYSTEM ALERTS

Alert	Description
Open Circuit Detection	All Functions (See Description in Alert)
Short Circuit Detection	All Functions (See Description in Alert)
Anti-Ice Feedback Sensor Jam Detected. Anti-Ice will Stop	Jam Detected from the sensor, anti-ice will stop until resolved
Auger Feedback Sensor Jam Detected. Auger will stop. Press Accept to continue in Open Loop Mode.	Jam Detected from the sensor, auger will stop until resolved
Auger Rate Limited	Auger running at Max current, output may not be accurate
Pre-Wet Feedback Sensor Jam Detected. Pre-Wet will stop. Press Accept to continue in Open Loop Mode	Jam Detected from sensor, pre-wet will stop until resolved.
Pre-Wet Rate Limited	Pre-Wet running at Max current, output may not be accurate
Spinner Feedback Sensor Jam Detected. Spinner will stop.	Jam Detected from the sensor, spinner will stop until resolved. <i>(Directional Bodies Only)</i>
Plow Down	Digital Input Active
Power Float Engaged	Digital Input Active
Filter Bypass	Filter is possibly clogged
Low Oil	Oil level is low
Hot Oil	Oil temperature is over threshold of 185° F.
Cold Oil	Oil temperature is under threshold of 35° F.
E-Stop	Turns off all electrical outputs and functionality <i>(Must be Configured)</i>
E-Retract	Retract select Outputs <i>(Must be Configured)</i>
Could Not Load System Configuration	SD Card may be corrupt system config lost
Files Transferred to USB Drive	System datalog files transferred to USB (manual data extraction)
Module lost (any)	Module not present on startup, disconnected, or no longer communicating with system
Module Not Found (any)	Module configured with system not detected on startup
Joystick Not Found	Joystick is not present on startup, disconnected, or no longer communicating with system
Invalid Password	Configuration menu password incorrect.
Panel Comm. Fault	GUI not communicating with panel processor. Generally due to corrupt processor firmware
Could Not Load Truck Profile	Profile incorrect format or wrong version
No Truck profile found on USB drive	Profile missing from USB Drive or incorrect format
Truck Profile Loaded	Profile loaded onto controller
Could not Download Truck Profile	Error transferring file to USB drive
Switched to GPS Groundspeed	Speedometer signal not found, system will use GPS groundspeed until resolved
AVL System Fault	Hidden until unit configured and connected to Muncie OMNI-System Plus

NOTES

NOTES



A Member of the Interpump Group

IN20-03 (Rev. 05 -22)

201 East Jackson Street, Muncie, Indiana 47305
800-367-7867 • Fax: 765-284-6991 • info@munciepower.com

Specifications are subject to change without notice. Visit www.munciepower.com
for warranties and literature. All rights reserved. © Muncie Power Products, Inc. (2018)