



Muncie[®]
Power
Products

KEEP IN VEHICLE

READ OPERATING INSTRUCTIONS
INSIDE BEFORE OPERATING PTO













FOR ALL 6-BOLT AND 8-BOLT MOUNT SERIES PTOS

PTO INSTALLATION
AND OPERATOR'S MANUAL



WARNING

READ MANUAL COMPLETELY INCLUDING THESE WARNINGS AND OPERATOR'S INSTRUCTIONS IN SECTION 3

-  READ AND UNDERSTAND ENTIRE MANUAL BEFORE INSTALLATION OR OPERATION OF PTO AND DRIVEN EQUIPMENT
 -  ALWAYS DISENGAGE THE PTO WHEN THE DRIVEN EQUIPMENT IS NOT IN OPERATION.
 -  DO NOT ATTEMPT TO INSTALL OR SERVICE ANY POWER TAKE-OFF WITH THE TRUCK ENGINE RUNNING. PUT THE IGNITION KEYS IN YOUR POCKET BEFORE GETTING UNDER THE TRUCK.
 -  DO NOT ALLOW TRUCK ENGINE TO BE STARTED WHILE WORKERS ARE UNDER THE TRUCK.
 -  IMMOBILIZE TRUCK WHEELS WITH SUITABLE CHOCKS BEFORE WORKING UNDER TRUCK.
 -  BE SURE TO BLOCK ANY RAISED BODY OR MECHANISM BEFORE WORKING ON OR UNDER THE EQUIPMENT.
 -  INSTALLED POWER TAKE-OFFS MUST NEVER BE SHIFTED IN OR OUT OF GEAR BY ANY MEANS EXCEPT BY THE CONTROLS IN THE CAB OF THE TRUCK.
 -  STAY CLEAR OF SPINNING DRIVESHAFTS TO AVOID BECOMING ENTANGLED AND INJURED.
- IT SHALL BE THE RESPONSIBILITY OF THE INSTALLER OF A MUNCIE POWER TAKE-OFF TO DECIDE WHETHER TO INSTALL GUARDS IN THE PTO AND/OR DRIVELINE AREA BECAUSE OF POTENTIAL EXPOSURE TO DANGER.
- THIS IS BECAUSE MOST MUNCIE POWER PTOS ARE INSTALLED BY EQUIPMENT DISTRIBUTORS OR MANUFACTURERS AND THEREFORE, THE RESPONSIBILITY OF THE INSTALLATION IS BEYOND THE CONTROL OF MUNCIE POWER PRODUCTS.
-  OBTAIN PROPER TRAINING BEFORE OPERATING THIS MACHINERY
 -  DO NOT INSTALL OR OPERATE EQUIPMENT WHICH HAS NOT BEEN PROPERLY SPECIFIED FOR YOUR EQUIPMENT.
 -  ALLOW THE VEHICLE, PTO AND DRIVEN EQUIPMENT TO WARM UP WHEN OPERATING IN WEATHER WHERE TEMPERATURES ARE NEAR OR BELOW FREEZING 32° F (0° C).
 -  INSTALL SEPARATE CONTROLS FOR PTO AND DRIVEN EQUIPMENT
 -  ALWAYS INSTALL THE SAFETY LABELS PROVIDED AND PLACE THE OPERATOR'S MANUAL IN THE VEHICLE GLOVE COMPARTMENT.

The PTO is supplied with a packet containing warning labels. If you did not receive any, or if you need extra, you may order them, no charge, by phone, email, or mail. They are available through your nearest Muncie Power Products distributor or at the number and address below:

1-800-FOR-PTOS (367-7867)

**Muncie Power Products, Inc.
P.O. Box 548
Muncie, IN 47308-0548**

info@munciepower.com

 **This symbol warns of personal injury.**



PTO OPERATOR'S MANUAL

FOR ALL 6-BOLT AND 8-BOLT MOUNT SERIES PTOS

TABLE OF CONTENTS

Section 1 PTO Installation

PTO Installation Instructions	1
Direct Mount Pump Installations	8
Adapter Plates & Assemblies	10
Adapter Gear Installation	11
Filler Blocks	11

Section 2 Activation Kit Installation

Activation Kit Installation Instructions	12
Lever Shift Control	12
Cable Shift Instructions	13
Indicator Light Switch Continuity Check	17
PTO Equipped with Magnetic Pick-Up Sensor	17
TG Series Lectra Shift System	18
Switch and Light Installation	18
TG Series Wiring Diagram for E-Hydra-Shift	19
TG Series Standard Air Shift System	20
TG Series Electric/Air Shift System	20
82 Series Double Acting Air Shift System (R Option)	21
Instructions for Push/Pull Manual Air Valve	21
82 Series Double Acting Air Shift System (S Option)	22
RL Series Standard Air Shift System	22
Eaton Fuller Automated Manual	22
AISIN Automatic Transmission Models	23
AISIN Automatic Transmission 6-Speed	23
AISIN MY600 and A465, ISUZU, and Hino	24
Automatic Transmission Diagrams Application Information	26
Allison Automatic Transmission 1000, 1700, 2000, 2400, and 2700 Series	27
Allison Automatic Transmission 1000 or 2000 Series	28
Clutch Shift and SH Series Standard Air Shift System	29
Clutch Shift Electric/Hydraulic Shift System (on automatic transmission)	30
Clutch Shift and SH Heavy Electric/Air Shift System	31
Clutch Shift Electric/Hydraulic Shift System (with Integral Solenoid on Automatic Transmission)	32
Clutch Shift Instructions & Tests	33

Section 3 Operator's Manual

PTO Shifting Procedure & Precautions	34
Clutch Shift Operating Notes	36
PTO Maintenance	36
Indicator Light Check	37
PTO Torque & Horsepower Ratings	38
PTO Troubleshooting Guide	39
Power Take-off Warranty	41

SECTION 1

PTO INSTALLATION

PTO INSTALLATION INSTRUCTIONS

Always wear safety glasses. Read entire manual before starting installation.

1. There is a packet with the PTO which contains 4 WARNING LABELS. Before adhering the labels, make sure the surfaces are free of dirt and grease. Place the labels supplied as follows:

There are two (2) labels which measure approximately 4" x 8" which are to be placed on the outside of the vehicle frame rail, making them easy to be seen by anyone who might go under the truck or near the PTO. One label is to be placed on each side of the vehicle. See Figure 1.

Should the body installed on the chassis cover the frame rail, place the label on the body in a position easily visible by anyone who might go under the vehicle or near the PTO. **Do not paint over labels.**

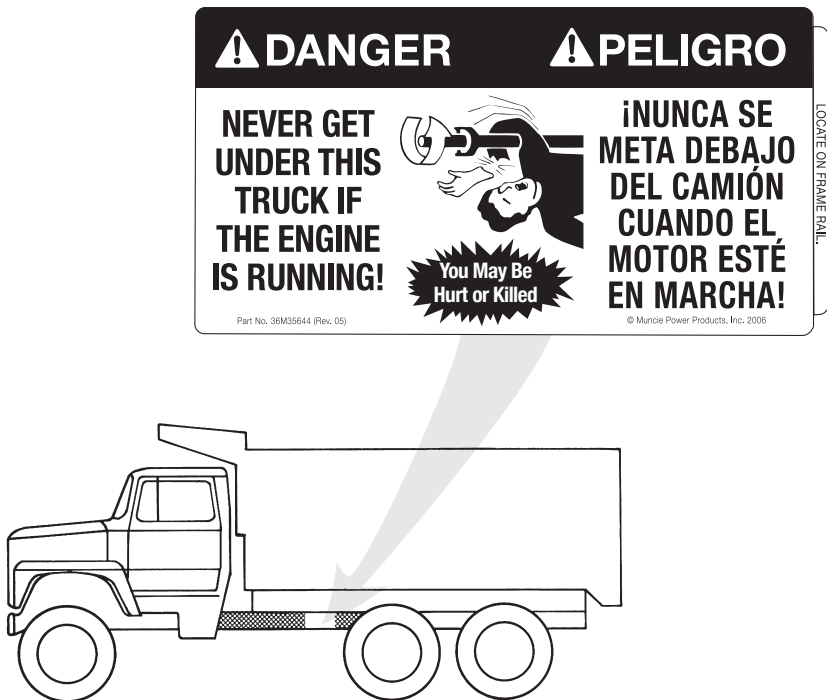
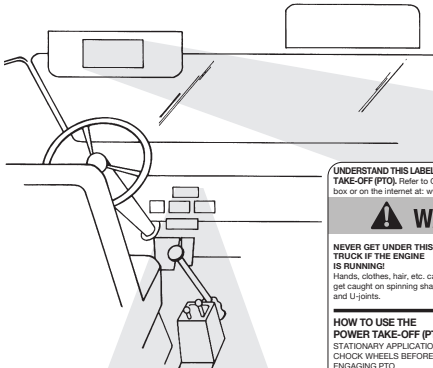

Figure 1

There are two (2) 4" x 8" labels supplied and one is to be placed on each side of the vehicle.

2. The 2" x 3" PTO Equipped Caution Label is to be placed within the cab of the vehicle and in easy view of the vehicle operator. It should be located near the PTO control, when the control is installed in the vehicle dash. See Figure 2. This label directs the operator to read the PTO operating instructions on the "Visor Label". The Visor Label 4" x 6½" is to be placed on the visor on the operator's side of the vehicle. See Figure 2. Do not mount this label on the same side of the visor as the air bag warning label if so equipped. Vehicles with hydraulic dump pumps are provided with a Warning label to be mounted in clear view of the operator while seated in the driver's seat.



UNDERSTAND THIS LABEL BEFORE USING POWER TAKE-OFF (PTO). Refer to Operator's Manual in glove box or on the internet at: www.munciepower.com

LEA Y COMPRENDA ESTA ETIQUETA ANTES DE USAR LA TOMA DE FUERZA (TDF). Consulte el Manual del operador que viene en la guantera o por internet en: www.munciepower.com

WARNING

NEVER GET UNDER THIS TRUCK IF THE ENGINE IS RUNNING! Hands, clothes, hair, etc. can get caught on spinning shafts and U-joints.

YOU MAY BE HURT OR KILLED. It is against Federal Law to try to fix PTO driven machinery if the engine is running. Always turn the engine off. Then, put the keys in your pocket. (2004-1012-10)

HOW TO USE THE POWER TAKE-OFF (PTO) STATIONARY APPLICATIONS. CHOCK WHEELS BEFORE ENGAGING PTO.

Manual Shift PTOs (Including Air Shift)
Automatic Transmissions

1. Let engine idle.
2. Apply brakes, while seated in driver's seat.
3. Place shift selector in any drive range.
4. Engage PTO.
5. Shift transmission to neutral or park.

Manual or Automatic Transmissions

1. Let engine idle.
2. Engage PTO with switch.
3. Resume operating speed.

ADVERTENCIA

¡NUNCA SE META DEBAJO DEL CAMIÓN CUANDO EL MOTOR ESTÉ EN MARCHA! Las manos, la ropa, el cabello, etc. pueden quedar atrapados en los ejes giratorios y las juntas universales.

PUEDA SUFRIR UNA LESIÓN O LA MUERTE. La ley federal prohíbe tratar de reparar maquinaria accionada por toma de fuerza si el motor está en marcha. Siempre saque el motor. Luego, ponga las llaves en su bolsillo. (2004-1012-10)

CÓMO USAR LA TOMA DE FUERZA (TDF) APLICACIONES ESTACIONARIAS

TDF de cambio manual (incluidos los cambios de activación neumática)
Transmisiones manuales

1. Deje el motor al ralentí.
2. Mantras permanece en el asiento del conductor, accione el freno.
3. Coloque el selector de cambios en cualquiera de las posiciones de manejo.
4. Active la TDF.
5. Lleve la transmisión a punto neutro o de aparcamiento.

TDF de transmisión servomecánica
Transmisiones manuales o automáticas

1. Deje el motor al ralentí.
2. Active la TDF con el interruptor.
3. Retorne la velocidad de funcionamiento.

Part No. 36T3924 (Rev. 04)
© Muncie Power Products, Inc., 2006

WARNING

THIS VEHICLE IS EQUIPPED WITH A POWER TAKE-OFF

READ AND UNDERSTAND OPERATOR'S MANUAL BEFORE USING THIS MACHINE.

FAILURE TO FOLLOW OPERATING INSTRUCTIONS COULD RESULT IN DEATH OR SERIOUS INJURY.

© Muncie Power Products, Inc., 2005

ADVERTENCIA

ESTE VEHÍCULO ESTÁ EQUIPADO CON UNA TOMA DE FUERZA

LEA Y COMPRENDA EL MANUAL DEL OPERADOR ANTES DE USAR ESTA MÁQUINA.

NO SEGUIR LAS INSTRUCCIONES OPERATIVAS PUEDE PRODUCIR LA MUERTE O LESIONES GRAVES.

(LOCAR: USAR E AND USAR PTO CONTROL)

Part No. 36M3562 (Rev. 03)

WARNING

THIS VEHICLE IS EQUIPPED WITH A POWER TAKE-OFF & HYDRAULIC DUMP PUMP

FAILURE TO DISENGAGE THE PTO AND DUMP PUMP WHEN NOT REQUIRED CAN RESULT IN EQUIPMENT DAMAGE AND/OR SERIOUS PERSONAL INJURY.

Muncie Power Products, Inc., 2005

ADVERTENCIA

ESTE VEHÍCULO ESTÁ EQUIPADO CON TOMA DE FUERZA Y BOMBA HIDRÁULICA DE VOLTEO

EL HECHO DE NO DESACTIVAR LA TDF Y LA BOMBA DE VOLTEO CUANDO NO ES NECESARIO PUEDE PRODUCIR DAÑOS AL EQUIPO Y/O LESIONES PERSONALES GRAVES.

(COLOCAR ETIQUETA DE LOS CONTROLES DE LA TOMA DE FUERZA Y LA BOMBA DE VOLTEO EN EL PTO O EN EL CONTROL)

Part No. 36T40283 (Rev. 03)

Figure 2

3. Manual Transmissions: While driving the truck into the work bay, note if a delay is required between depressing the clutch and shifting the main transmission gear selection. If the gear does not come to a complete stop within a few seconds, the clutch linkage on the truck must be adjusted before installing the PTO. Run transmission in neutral. Determine sound of transmission before the PTO is installed. A transmission noise may be more noticeable after PTO is installed.

Stop engine.

4. For manual shift transmissions, drain transmission fluid. For Allison automatic transmissions, do **not** drain transmission fluid, but be prepared for a small amount of oil to escape from opening.

Remove cover plate. Place a shop towel in the opening to prevent dirt from getting in the transmission.

Examine cover plate. If there is a magnet attached to the inside, reinstall this cover on the other opening.

Clean mounting pad. Inspect bolt holes in aperture for thread sealant used on OEM bolts. Clean these internal threads with wire brush to clear the material. **Remove shop towel.**

5. Check transmission for proper PTO driver gear and location. Do not place anything in or near PTO opening while the engine is running.

Stop engine and remove keys before proceeding to next operation.

Check PTO driver gear for condition. A nick or blemish may cause excessive noise when PTO is mounted.

6. Rock transmission gears by hand to get “feel” for gear backlash manufactured into transmission gear set.

7. Open the PTO carton and find the mounting kit (studs and cap screws) enclosed with your PTO. Visual inspection of the PTO will indicate which mounting holes in the PTO will not accept cap screws. Install the enclosed studs in the transmission housing holes that correspond to those PTO holes which will not accept capscrews. Additional instructions may be found on the supplement sheet enclosed with PTO. Install adapter gear at this point if it is required. (Go to page 10 if adapter gear is used.) PTOs with mounting option “6F” have two dowel pins which need to be placed in the mounting pad before mounting PTO.

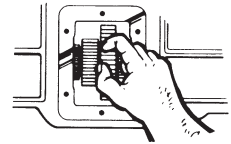
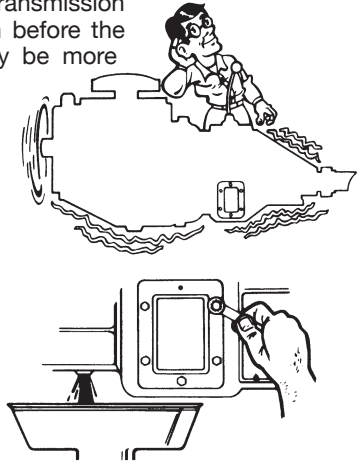

8. Install the studs until the barrel of the stud is even with the transmission pad. This typically requires a torque limit of 30–35 lbs.ft. (6-Bolt pad) or 45–50 lbs.ft. (8-Bolt pad). If more torque is required to install the stud to the barrel or to the depth shown in the below table then remove the lock patch from the stud and the transmission mounting holes and use a liquid Loctite® 242 in its place.

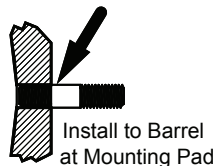

The studs should be engaged to the minimum depth as shown below:

Stud Dia.	No. Threads	Approx. Depth
3/8"	7–8	1/2"
7/16"	8–9	5/8"
10mm	9–10	1/2"

9. Remove the shifter cover or the inspection cover plate from the PTO by removing the hex head cap screws on the cover plate. With PTOs which do **NOT** have an inspection cover plate, hold the output shaft and rock input gear to get the “feel” of backlash built into the PTO. This “feel” will be helpful when fitting PTO to transmission. See Step 12.

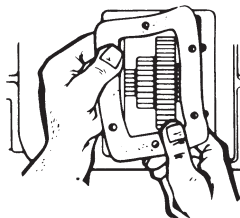

10. Place mounting gasket/shim from your kit over the studs already installed on the transmission. A thin coating of approved transmission oil is recommended on gasket/shims to help seal and to hold them in place during installation.

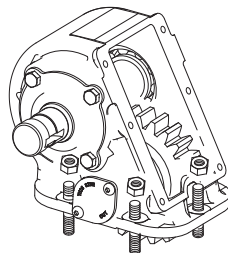

Do **not** use a permanent sealant on gasket/shims because you may need to change them later. Use approved transmission oil only!

11. Position the PTO on the studs and start the nuts provided onto the studs. Do Not Tighten Yet. Check for gaps between the PTO and transmission and make sure gear teeth are properly meshed and then tighten the top and bottom nuts or cap screws. On some transmission models the TG Series PTO may encounter interference with the idler shaft cap. Special clearance caps may be used and are listed in the application catalog where known interference exists.

12. Check the backlash on the input gear (the gear that meshes with transmission gear) by feeling through the inspection hole or shift cover opening previously uncovered in Step 9. The amount of rotational movement of the PTO gear should be only .006" to .012". As a reference, the thin gasket/shim in your installation kit is .010" thick. The thin gasket/shim (.010" thick) will change the backlash approx. .006". The amount of movement of the input gear would only be about the same distance as this gasket/shim thickness. At least one gasket/shim **must** be used. Do not stack more than (4) gasket/shims together. On Allison transmissions (Series AT-500, MT-600, and HT-700 only) the single .030" gasket/shim

(13T63989) should be required and is supplied with PTO. On Allison 1000, 1700, 2000, 2400, and 2700 Series transmissions, CS6B-A67 PTOs in 03-05 ratios ship with two .030" gaskets/shims. The CS6B-A6707 Series and TG6B-A69** Series use a spacer and require gasket/shims and backlash checks as described below.

Special Instructions for Allison 1000 & 2000 Series Transmission Installations

Noise can occasionally be emitted from the PTO when installed on the Allison 1000 and 2000 Series transmissions that may be objectionable to the operator. The following instructions assist in reducing this noise. Noise emitting when the unit is disengaged and the reduced or extinguished when unit is engaged is common for this installation and is not a signal of advanced failure. Muncie Power Products does not consider this noise to be a warrantable condition.

TG SERIES

When installing the TG Series note that the PTO is provided with several gaskets and a steel spacer 23M60270X.

Install the PTO using two .020" thick gaskets provided, using one on each side of the spacer.

Check the backlash.

If the PTO is noisy in the off mode, but quiet when engaged, then remove PTO and re-install with all of the gaskets provided.

CS6 SERIES

CS6B-A6707 ratio: Install the PTO using two .020" thick gaskets provided, using one on each side of the 23M60350 spacer provided with PTO.

Check the backlash.

If the PTO is noisy in the off mode, but quiet when engaged, then remove PTO and re-install with all of the gaskets provided.

Notice: For some Warner W80 applications, a maximum of one thin gasket/shim (.010") is required. If backlash is too excessive, remove the gasket/shim and use Loctite® 515 Gasket Eliminator™ sealant Muncie #13M51717. A .20 ounce tube has been supplied with the PTO for these applications.

Use of a dial indicator can greatly improve the quality of the installation. Mount the indicator so that the plunger aligns with a tooth on the PTO input gear. Hold the transmission gear with screw driver or bar and rock the PTO gear back and forth with your hand. The total movement on the dial indicator should be between .006"–.012".

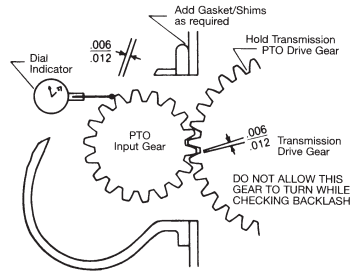

Check the backlash at different points around drive gear to find the worst condition. NOTE: Never use silicone type sealant on PTO/transmission mounting surface as proper backlash cannot be attained.

13. Torque all the mounting cap screws or nuts to 40–45 lb.ft., (6-Bolt pad) or 50–55 lb.ft., (8-Bolt pad) unless noted in a separate stud kit instruction. Failure to properly tighten capscrews or nuts can lead to leaks. PTO and/or transmission damage can occur. **Improper installation, tightening, or leaks are not the responsibility of Muncie Power Products, Inc.**

Recheck the backlash.

The PTO gear should not move more than .012 or less than .006 when all mounting nuts or bolts have been torqued.

14. Replace shifter cover or inspection cover plate and gasket on the PTO. **Shifter cover gasket can be found in the instruction envelope. It is required to use a gasket under the shift cover.** Torque cap screws to 14–18 lb.ft. Double check to make sure the shifter fork is in the groove on gear or shift collar before tightening cap screws. On the TG Series shifter cover, the installation and torquing of the capscrew should be in an “X” pattern starting with the center capscrews and crossing the cover during installation. Torque the capscrews using the same pattern.

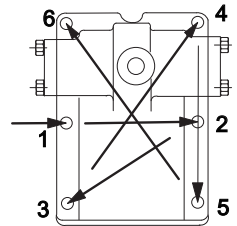

**“X” Pattern
(TG Series Only)**

15. Start the truck engine (with transmission and PTO in neutral) for a few seconds and listen for unnatural noises. Stay clear of rotating components. A whine noise indicates the PTO is mounted too tight. **Stop engine** and add a gasket/shim. A clatter noise indicates a loose mount. **Stop engine** and remove a gasket/shim. Add sealant (Loctite® Gasket Eliminator™) if no gasket is used.

- A PTO will not always make these noises.
- Do Not adjust backlash by noise alone, always visually check back lash.
- Sometimes filling the transmission with lube is the only way to reduce the noise.
- A tight mounted PTO will cause under cutting of gears and result in premature PTO failure, including gear or housing breakage.
- If OK, repeat test with PTO engaged.

Caution: Keep PTO/transmission running time as short as possible until transmission is refilled with lube. Do not drive the truck without transmission lube.

16. Refill transmission with manufacturer's approved fluid and run engine for 5 to 10 minutes to check for leaks. **Stay clear of rotating components. Stop Engine! Inspect the cap screws, nuts, and studs to make sure they are properly tightened.**

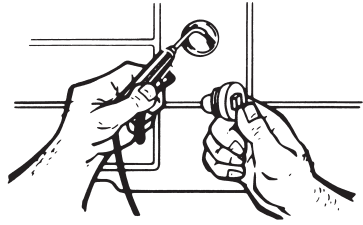

17. Install the appropriate shifter kit components, including the supplied PTO shift indicator light. Refer to page 12 for Lever Shift, page 13 through 16 for Cable Shift, page 18 for the Lectra Shift TG Series PTO, pages 20 through 21 for Air Shift PTOs, and pages 29 through 33 for Clutch Shift PTOs.

On air system only, you will not receive any air through the pressure protection valve to the PTO system until your main tank pressure exceeds 65 PSI.

18. If your system utilizes a driveline between the PTO and another device and if you have noise in your system that was not there before, the angularity or phasing of your driveline may be the cause. Check driveline angularity and reduce total angularity per recommendation on chart and be sure the PTO shaft is parallel within 1.5° to the pump shaft (or driven unit). Drivelines must be in phase, that is, the yoke ears on the PTO and pump shafts must be in alignment, as illustrated below. PTO with Direct Couple Hydraulic Pump Installation.

Max. Speed (RPM)	Max. Angle TJA "A"
3,500*	5°
3,000*	6°
2,500	7°
2,000	8°
1,500	11°
1,000	12°

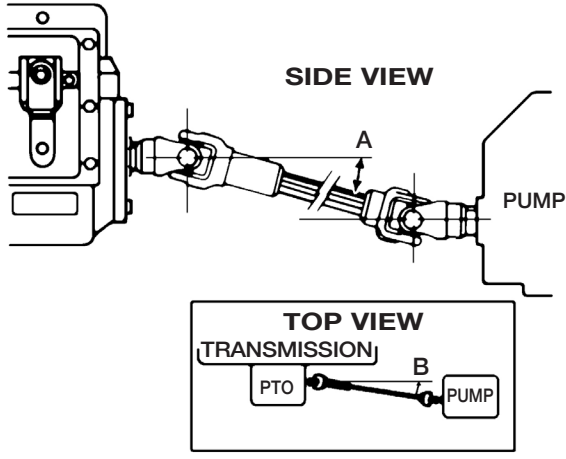

* For speeds over 2,500 RPM contact Muncie for Approval.

For installations with angles in the top and side views use this formula to compute the true joint angle (TJA):

$$TJA = \sqrt{A^2 + B^2}$$

FOR DIRECT MOUNT HYDRAULIC PUMP INSTALLATIONS

Before bolting the pump to the PTO, place non-seizing compound or grease on the PTO shaft and pump shaft.

All Muncie Power direct mount PTOs are supplied with the appropriate grease. Reusing an existing pump will require inspection of the pump splines. Clean any old grease from pump prior to installation.

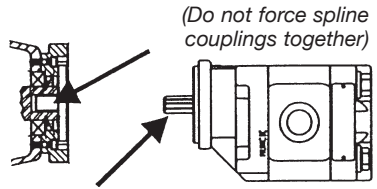

When mounting hydraulic pumps weighing over 40 lbs.*, exceeding 12" in length, or for tandem or multiple section pumps, a rigid support bracket must be installed. It should be attached to the rear of the pump and to the transmission to support the pump and to inhibit movement in all directions.

**Weight includes fittings, oil, and unsupported hose sections.*

This requirement does not take into account the system duty cycles, vehicle vibrations, application, terrain, and other external influences. We recommend that direct mounted components of any size or weight be supported when these conditions are extreme or unknown.

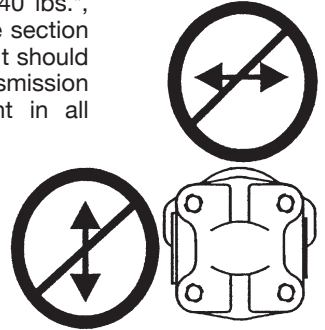

This recommendation is based upon our experiences to date. Bracket design illustrations and pump recommendations is to be used as a **GUIDELINE ONLY**. Bracket design shown is representative and is not to be duplicated for all applications. Any failure as a result of damage caused by unsupported weight attached to the PTO will affect any warranty considerations.

The drawings below are examples of how the bracket may be constructed. A bracket attached to two or more transmission bolts and two pump bolts is required. The bracket design should assure that there is no stress or force exerted on the pump or PTO shaft.

If the vertical supports are greater than 20 degrees off of perpendicular with the transmission main shaft then a reinforced "Z" bracket must be used. Reinforce horizontal members to prohibit flexing at bend or weld. Attach the bracket at the pump bolt closest to the center of gravity of the pump.

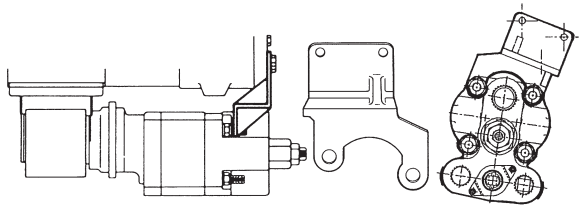

If the vertical supports are greater than 20 degrees off of perpendicular with the transmission main shaft then a reinforced "Z" bracket must be used. Reinforce horizontal members to prohibit flexing at bend or weld. Attach the bracket at the pump bolt closest to the center of gravity of the pump.

Most Muncie Power direct mount flanges offer multiple mounting bolt holes which allow the flange to be rotated to multiple locations on the PTO for improved port location or clearance. Be sure to torque the cap screw to 25 ft.lb., and it is advisable to use a thread locker to secure the cap screws (Loctite® 241, NyLoc, or equivalent).

19. Greaseable hydraulic output shaft option PTOs with the “G” special feature option have a grease zerk fitting behind a cover on the closed end cap of the output shaft. Grease needs to be added after the pump has been installed using a grease gun. Use a high temperature, high pressure, EP type grease.

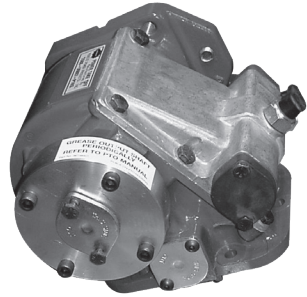

20. FOR CABLE OR LEVER SHIFT INSTALLATIONS ONLY.

For **CLUTCH SHIFT** installations, skip to pages 29–33.

Using the metal plate as a template, drill holes in dash near cable knob and attach indicator light as shown at right.

Battery connection should be an “ACC” tap on fuse panel.

Install light in a position which is visible to the operator when operating the PTO and the vehicle.

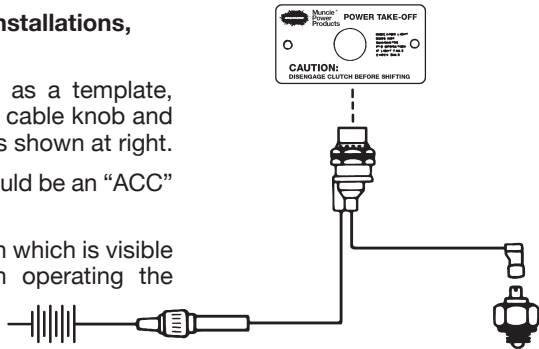

The indicator light is to be connected so that when the PTO is engaged the light is “ON” and the light is “OFF” when the PTO is disengaged.

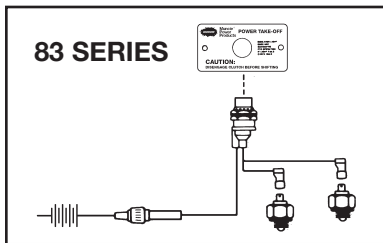

Do not install any other electrical devices to the Muncie Power indicator switches, or to pressure switches.

21. Complete installation by confirming warning labels have been placed as indicated on borders of the decals. Placement examples are illustrated on pages 1 and 2. Turn to Section 3, page 34 of this Operator’s Manual.
22. Operate the equipment for an appropriate amount of time established for proper operation or per the equipment manufacturer’s recommendation. After shutting down equipment and engine, check for leaks. Allow unit to sit for 60 minutes, then check again for any leaks. Fix all found leaks per manufacturer’s recommendation.

Muncie Power Products, Inc. is not responsible for any damage resulting from installation, mounting torque or maintenance of the PTO.

ADAPTER PLATES & ASSEMBLIES

See Muncie Power Products Quick Reference Catalog for specifications.

ADAPTER PLATES are used to convert an SAE 8-Bolt aperture to an SAE 6-Bolt aperture.



Adapter Plate

Adapter plates mount to the transmission pad with included gaskets and capscrews. The ¼" plate has a raised pad to provide proper thread engagement. This raised pad is to be mounted toward the transmission opening and the PTO is mounted to the flush side of the plate.

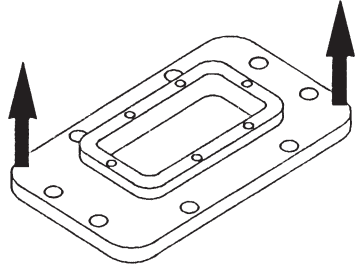

Mount Towards Transmission

ADAPTER GEAR ASSEMBLIES are normally used to reverse the rotation of the PTO output shaft. They are also commonly specified to clear mounting obstructions. Standard adapters will move the PTO outward from the transmission approximately three inches. Adapters often reduce the application horsepower ratings and service life. Contact Muncie Power Products for specific information regarding your application.



Solid Body - Single Gear



Angular Cluster Gear



Flanged Body - Single Gear

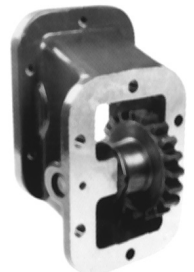

Vertical Offset Gear

ADAPTER GEAR INSTALLATION

Before installing the adapter gear be sure to read all of the instructions in this booklet for installing a PTO. Follow all the safety instructions listed when installing the adapter as you would for installing the PTO. Make sure that the engine is turned off and wheels are immobilized before starting any installation.

1. Follow steps 1 through 7 on pages 1 through 3 of this manual.
2. Before attempting to mount adapter to transmission, bench mount the adapter to the PTO using studs or capscrews in at least the top and bottom stud holes.
3. Using gaskets and spacers (if required) adjust the backlash between the adapter and the PTO so that it is between .006" to .012". Some adapters are supplied with gasket eliminator instead of gaskets. Apply a bead evenly around the surface of the mounting pad.
4. After spacing between PTO and adapter is adjusted remove the adapter from the PTO and carefully save the Gasket Pack you have just created. Mount the adapter to the transmission using at least the top and bottom stud holes. Adjust the backlash of the adapter to the transmission so that it is .006" to .012" inches. Refer to steps 8 through 12 on pages 3 through 5 for additional instructions on backlash.
5. Using the Gasket Packs created from earlier steps, mount the PTO to the adapter using all six studs stud holes and return to the instructions on page 4, step 8 and continue the installation until completed.

FILLER BLOCKS/SPACERS

FILLER BLOCKS are often required in transmission applications where it is necessary to use a spacer to adapt the PTO to a particular transmission. Two filler blocks may be used in combination with one or more gaskets between the filler block surfaces. A minimum of one (1) gasket is required between each surface. Refer to notice supplied with the filler block for more information.

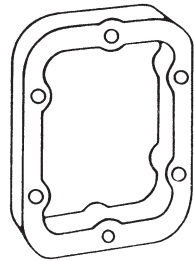

SECTION 2

ACTIVATION KIT INSTALLATION

ALL INSTALLERS MUST READ THE FOLLOWING

ACTIVATION KIT INSTALLATION INSTRUCTIONS

IMPORTANT: Disconnect vehicle battery and bleed air tanks with engine stopped prior to installing electrical or air activation kits.

1. Vehicle manufacturers may have specific locations for the accessing of electrical power, activating hydraulics, and air. The body builder manual or company representative for the vehicle chassis should be contacted prior to installing electrical or pneumatic systems.
2. Route wires, hydraulic activation lines, and air lines away from rotating and high temperature components. Use appropriate looms and bulkhead pass-throughs wherever possible to avoid rubbing through insulation or tubing and causing an electrical short or air leak.
3. Follow all Federal Motor Vehicle Safety Standards (FMVSS) for your vehicle.
4. Where electrical grounds are indicated, be sure that they are good grounds, with straight paths to the vehicle battery ground. (Many vehicle cabs are insulated from the vehicle frame and a weak ground is a very common cause for malfunctions). Check with the vehicle manufacturers for the proper ground location or connect directly to battery.
5. When installing hydraulic components, be certain to follow common installation and testing procedures. If you are not familiar with acceptable installation procedures request instructions and guidance from the hydraulic equipment supplier.
6. Note that when installing the PTO air systems the installation of a pressure protection valve is required at the air tank. This valve is not a pressure regulator, it is a pressure check valve which does not allow air to the PTO system until the system air pressure exceeds approximately 65 PSI.
7. Cold weather start conditions require that the transmission be started and warmed prior to engaging and using equipment. Hydraulic pumps should be run at idle and under no load conditions to allow oil to warm before activating hydraulic system.

LEVER SHIFT CONTROL

Install indicator light as described on page 9, step 20.

Muncie Power PTOs with lever shift options (available on *RL and 82 Series only) require the customer to provide the linkage and hook-up to the PTO. The PTO is provided with an eye bolt for this purpose.

The PTO is designed with detent ball and spring to locate the engage and disengage positions, but it is **not** designed to lock into these positions. A neutral detent to prevent unintentional or accidental engagement **must** be installed on the external shift linkage. This detent must be included by the installer of the linkage.

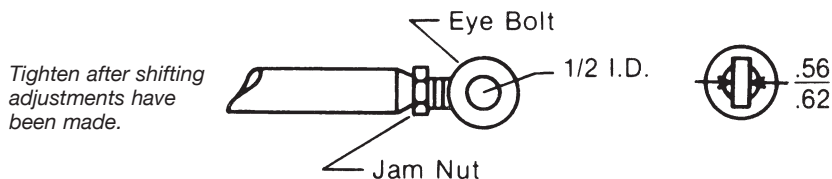

CABLE SHIFT INSTRUCTIONS

TG SERIES PTO

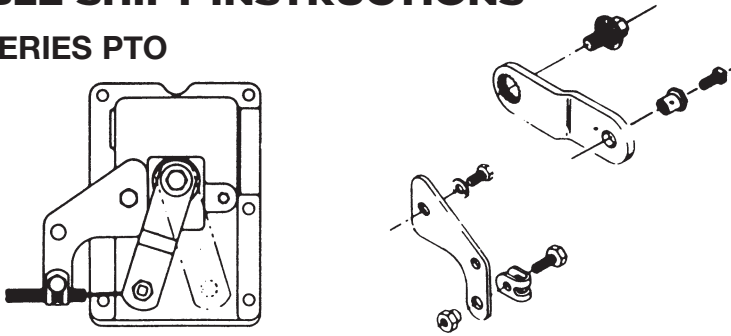
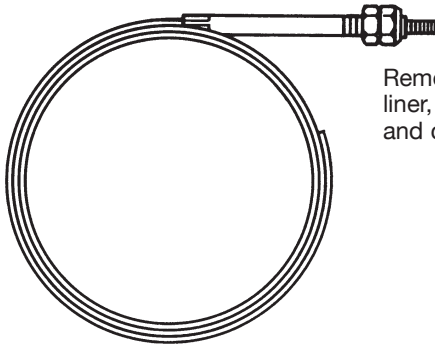

Figure 3

WARNING: All cable shift controlled PTOs are designed to be shifted only by wire cable. The unauthorized attachment of lever control linkage to a cable control mechanism may cause damage to shifting components and, subsequently, the transmission. The unauthorized attachment of the lever control linkage to a cable control mechanism may cause the PTO to engage unintentionally due to linkage bounce or flail.

CABLE SHIFT INSTALLATION INSTRUCTIONS

Be sure vehicle is not running when installing or adjusting cable control. After removing the cable from shipping liner (being very careful to hold cable so that it cannot uncoil and cause injury) straighten cable at crimp that has resulted from being coiled. Make sure cable has free travel before installing.



Remove Cable from shipping liner, so that it cannot uncoil and cause injury.

The coiling of the cable causes a kink at the crimp. Straighten this before installing cable.



Make sure cable has free travel.

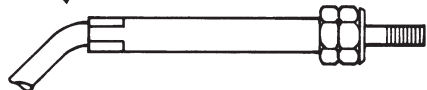

Figure 4

1. Find a suitable location for the control cable and the indicator light. The cable control should be installed so that the operator has easy access to push in and pull out the control without obstruction or interference by other controls or components in the cab.

2. Drill a 1/2" hole in dash or control bracket (not provided).
3. Install the control head through the hole and attach with the lock washer and nuts provided.
4. Knob can be screwed into place, using the jam nut to secure.

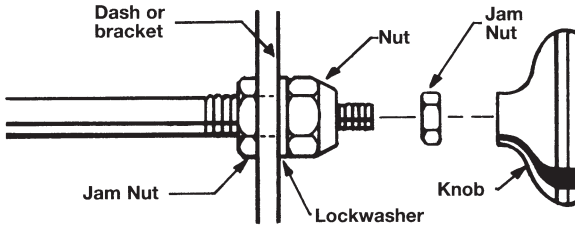

Figure 5

5. Route the length of cable through the floorboard or firewall and to the PTO. The cable needs to be routed clear of manifold, exhaust systems, and rotating and moving components. When routing the control cable avoid kinking the cable and do not bend to radius of less than 6"

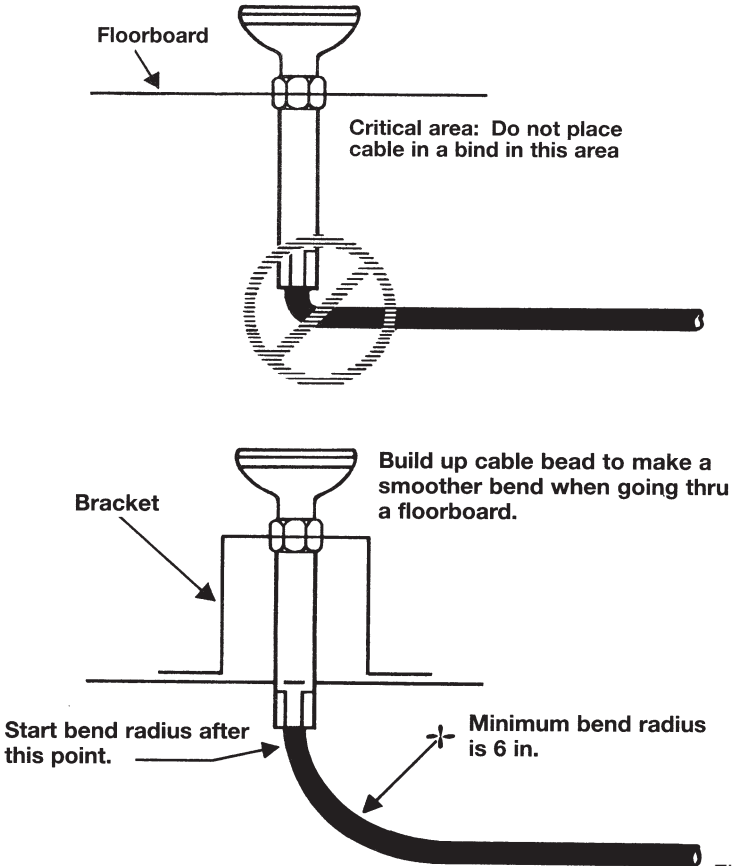
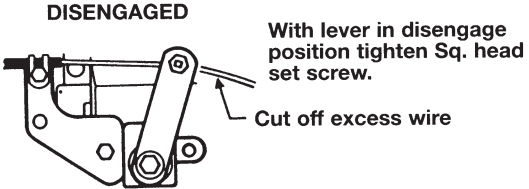
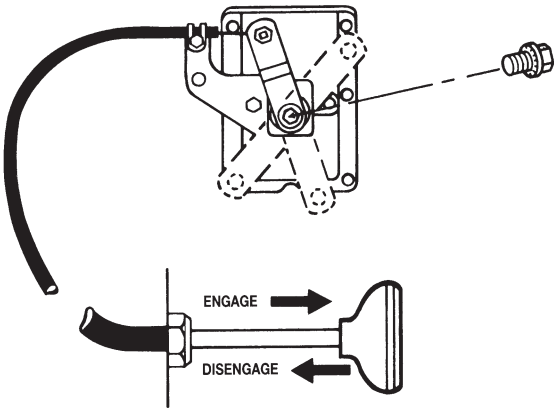

Figure 6

6. The lever on the PTO shifter assembly is designed so that it can be moved to allow the cable approach to be from the front or the back of the PTO. This should be determined by the routing method causing the least amount of bends and the shortest cable length.
7. The lever, also must be positioned so that when you pull on the control knob that the PTO engages.
8. To adjust the lever, mark the position of the lever where it's engaged when the cable would pull the lever. **Remove the shift cover from the PTO.** Remove the locking capscrew from the control lever. Lift the lever from the serrated post. Line up the lever with your mark. Line up the serrated hole and post making sure that the poppet and the shift plate are in their respective positions. Replace the locking capscrew and torque to 18 ft.lb. Reinstall shift cover assembly. Double check the installation by referring back to Step 7 above.



Move lever to its fully disengaged position and the cable knob to its fully disengaged position.

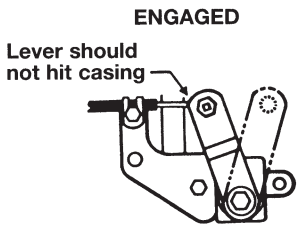

Figure 7

9. Referring to Figures 3–7 on pages 13–15, install the appropriate brackets, clamps, and hardware.

STANDARD PTO CABLE

If the cable is too long, remove the inner wire and cut casing (only) to length with a hacksaw or large side cutters.

If longer cables are required—they are available from your nearest Muncie Independent Master Warehouse.

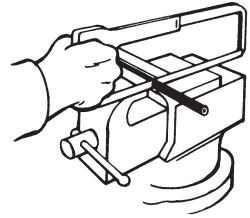

DELUXE (PT-65) PTO CABLE

Abrasive power cutting equipment is recommended for shortening this type of control cable. Do not use a bolt cutter or similar tool. Described here is a hand method for cutting cables where abrasive power cutting equipment is not available.

Make a holding tool by using a hardwood block of any convenient length as shown in the diagram. The hole should be of a size just large enough for the conduit to easily slip through.

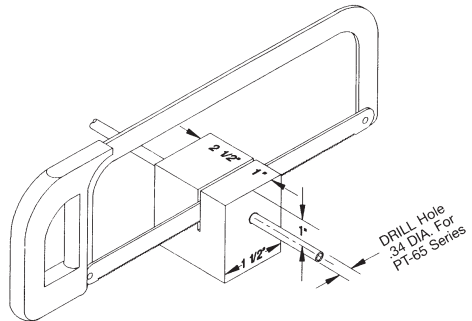

Typical Block Dimensions Shown

The hacksaw should have a fine tooth blade (no less than 32 teeth per inch). Remove the inner wire before cutting conduit by pulling the control knob end from the control head. Remove the installed cable end by unscrewing it from the cable conduit and saving it for reinstallation.

10. It is recommended that the control cable casing be securely anchored, with cable clamps, approximately every 30", to the frame and/or cab to prevent movement during shifting. Cable mounting clamps can be purchased from your nearest Muncie Power Products Independent Master Warehouse. (part no. MT306-4)
11. Install the indicator light and warning labels by referring to steps 20 and 21 on page 9 of this instruction booklet. The indicator light is to be "ON" when the PTO is engaged and "OFF" when the PTO is disengaged.

Do not install other electrical devices to the Muncie Power Products indicator light switch.

Install cable so that you pull to engage and fully pushed in to disengage.

The PTO indicator light must be installed so that it is visible to the operator of the vehicle while seated in the driver's seat. Additional indicator lights may need to be purchased to comply with this requirement.

INDICATOR LIGHT SWITCH CONTINUITY CHECK

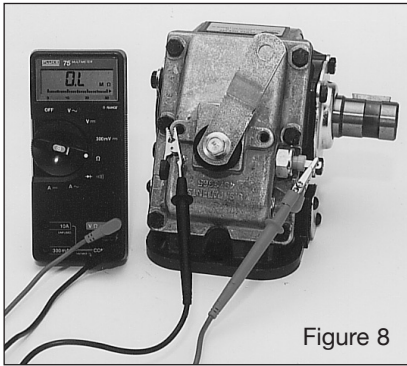

Figure 8

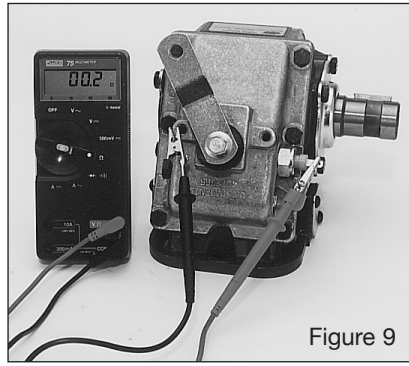

Figure 9

Performing a continuity check on the indicator switch will verify that the indicator switch is functioning and that the PTO is properly assembled.

1. Using a multimeter, connect one lead to the spade terminal on the indicator switch mounted to the PTO.
2. Connect the other lead to a bare metal portion of the PTO or shifter (Figure 8).
3. If the PTO is mounted on a vehicle, be sure that the engine is stopped, and the vehicle is safely immobilized to prevent any movement.
4. Engage the PTO. The meter will show continuity (Figure 9).
5. Shift PTO to the disengage position. The meter should return to normal (Figure 8).

This continuity check may be performed on any Muncie Power Products PTO. Only the air shifted models will require an air source to engage the PTO.

PTO EQUIPPED WITH MAGNETIC PICK-UP SENSOR

1. Mount the shift cover to the PTO (as required).
2. Align the internal gear tooth so that tip is centered in the pick-up opening.
3. Install the jam nut with the seal in the nut facing the PTO and back it down the pick up close to the wire end. Place washer then the O-Ring on the pick up so that the O-Ring will be against the PTO cover. Screw in the pick-up until the tip gently touches the top of the gear tooth.
4. Turn the pick-up backwards 2 turns. Rotate gear to make sure it clears.
5. Hold pick-up and tighten jam nut to hold in place.
6. Re-check gear for rotation.

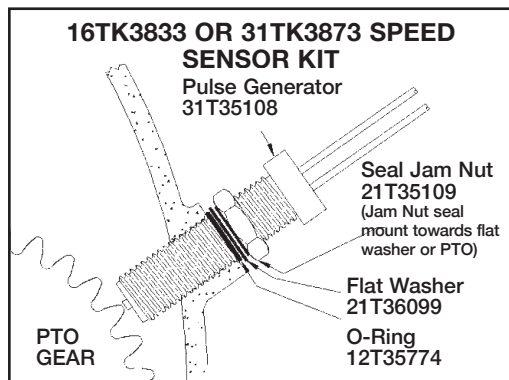

TG SERIES LECTRA SHIFT SYSTEM

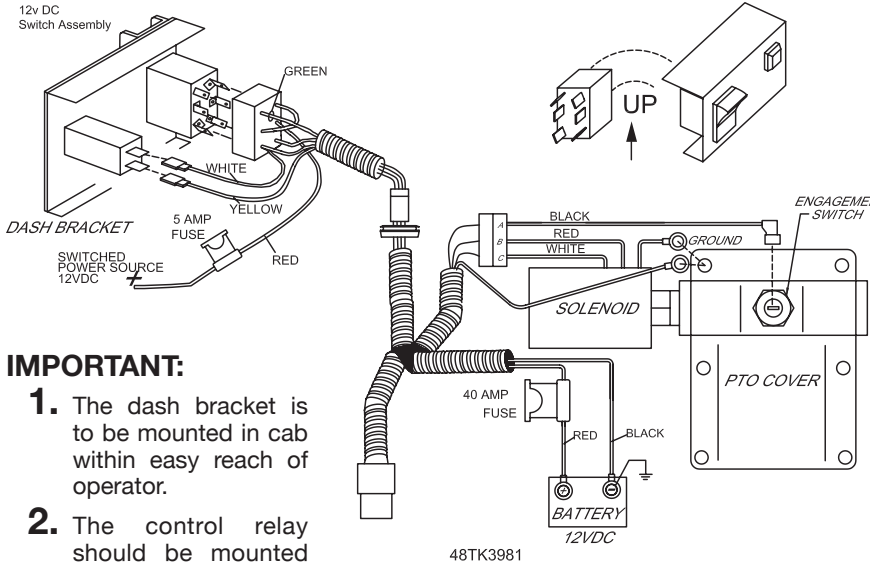

IMPORTANT:

1. The dash bracket is to be mounted in cab within easy reach of operator.
2. The control relay should be mounted on firewall in engine compartment.
3. 10 ga. wires from battery to relay and from relay to solenoid should not be lengthened.
4. PTO engagement is made by pushing rocker switch fully to the engage position and releasing switch immediately upon engagement.
5. Excessive repeated shifting of PTO can overheat solenoid and prevent engagement until allowed to cool down.
6. Drill .625 dia. hole in firewall near where control relay is mounted. Install black plastic grommet (P/N 37T35674) in hole and run the four-wire connector through the grommet and plug into cab harness portion of harness. Plug the rocker switch receptacle onto the switch so that the green wire is up matching the position of the green light on the rocker switch.

SWITCH AND LIGHT INSTALLATION

1. Remove protective film from faceplate.
2. Lay faceplate on switch bracket and push switch into faceplate and bracket so that the green lens on the rocker is up.
3. Insert the indicator by aligning the flat with the hole in the faceplate and bracket, then push the light into place.

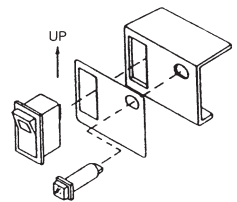

TG SERIES WIRING DIAGRAM FOR E-HYDRA-SHIFT

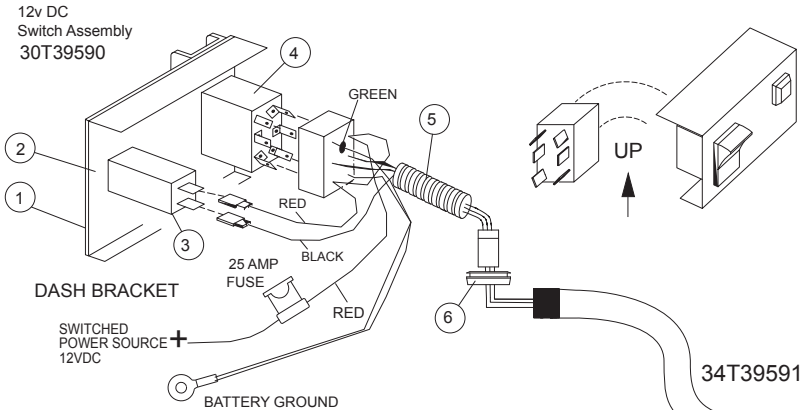

IMPORTANT:

1. The rocker switch and dash bracket **if used** is to be mounted in cab within easy reach of operator.
2. PTO engagement is made by pushing rocker switch fully to the engage position and releasing switch immediately upon engagement. (Indicator light will light)
3. Drill .750 dia. hole in firewall, install black plastic grommet (P/N 37T39628) in hole and run the three-wire connector through the grommet and plug into cab harness portion of harness. Note the orientation of the connector to insure proper assembly.
4. Plug the rocker switch receptacle onto the switch so that the green wire is up **matching the position of the green light on the rocker switch.** as noted in diagram.

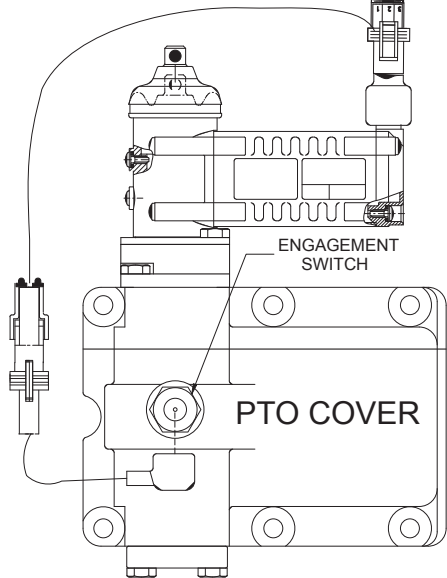

TG SERIES STANDARD AIR SHIFT SYSTEM

48M61250-A (12 V Light)
48M62450-A (24 V Light)

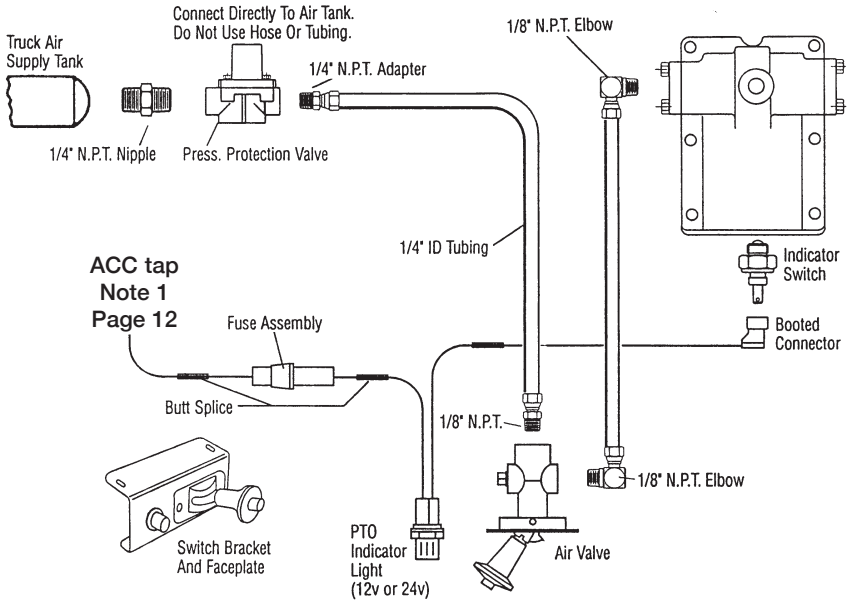

TG SERIES ELECTRIC/AIR SHIFT SYSTEM

48M61200-A (12 V Solenoid & Switch)
48M62400-A (24 V Solenoid & Switch)

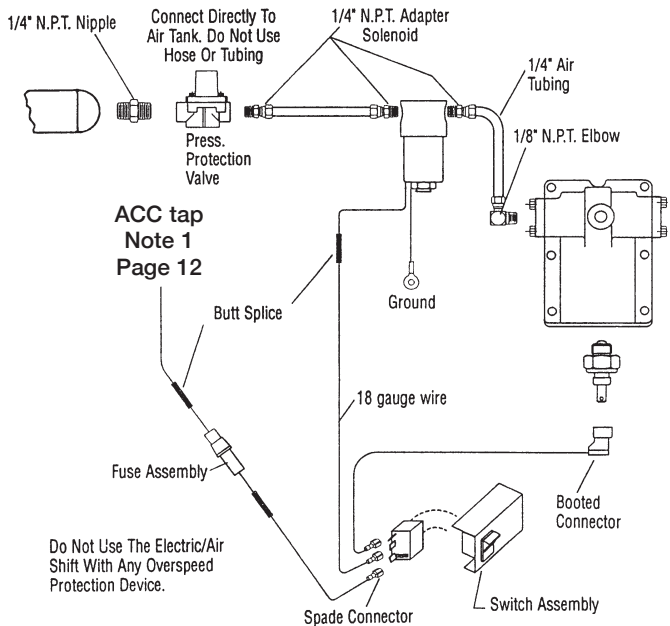

82 SERIES DOUBLE ACTING AIR SHIFT SYSTEM (R OPTION)

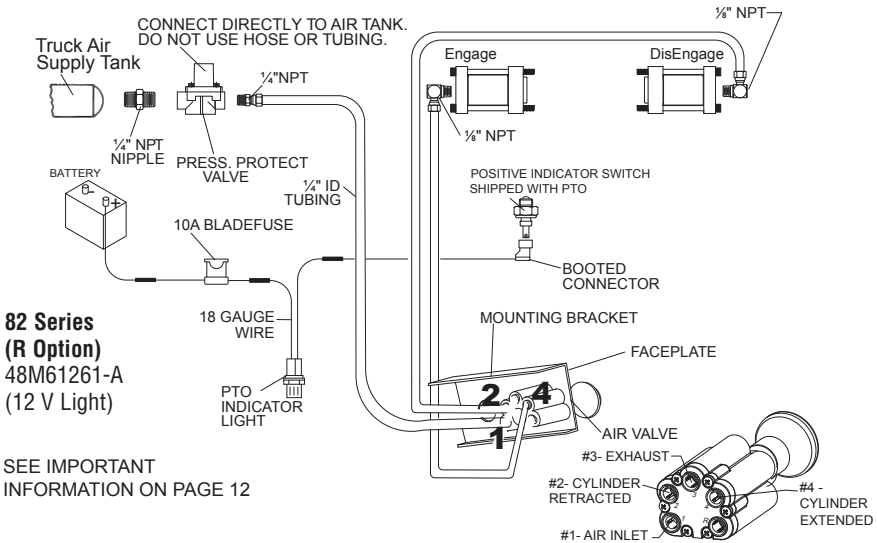

INSTRUCTIONS FOR PUSH/PULL MANUAL AIR VALVE

1. Remove the button cover (5) from the end of the air valve.
2. Using $\frac{3}{32}$ " Allen wrench remove screw (4) from knob. Hold red knob (3) to loosen screw.
3. Pull the red knob (3) from the valve stem.
4. Unscrew the hex nut (2) from the valve (1).
5. Install the valve (1) through the bracket (6) and face plate (7) using hex nut (2) to hold in place.
6. Place knob (3) over the valve stem, aligning the pin in the groove of the knob (3).
7. Insert screw (4) and tighten with $\frac{3}{32}$ " Allen wrench.
8. Push the button cover (5) onto the knob (3).

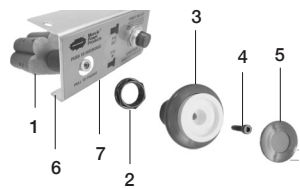
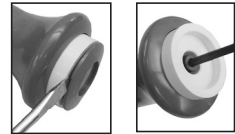

82 SERIES DOUBLE ACTING AIR SHIFT SYSTEM (S OPTION)

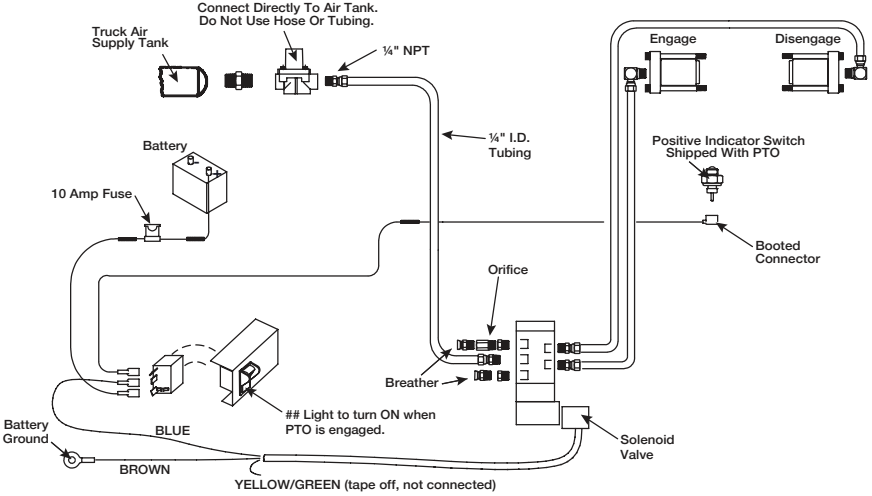

Note for 82 Series PTO: See special instruction i3158 when choosing NOT to use the Muncie Power supplied in-cab controls.

RL SERIES STANDARD AIR SHIFT SYSTEM

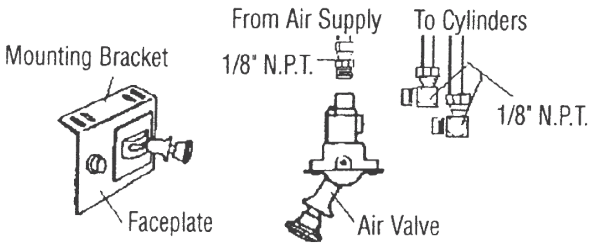

RL Series 48M61260-A (12 V Light)

EATON FULLER AUTOMATED MANUAL

Eaton/Fuller transmissions require connection to the transmission control module (TCM). To insure that the vehicle is properly specified for PTO use, contact the chassis dealer. For detailed information on connecting to the transmission TCM, refer to Eaton document TRIG-2600. Review their instructions for obtaining the Packard (Delphi) terminal described in the PTO section of the Eaton document.

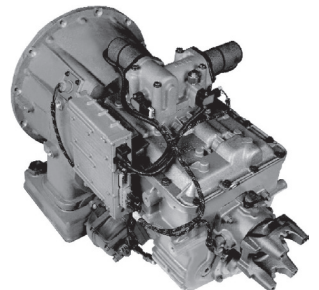

AISIN AUTOMATIC TRANSMISSION MODELS 450-43LE, A443, A445 5-SPEED

PTO Lube Tap (Port "B")
½-20 UNF-2B (SAE-5)
(56 PSI)
Use 43T37557 & 43T35867

Main Pressure (Port "P")
½-20 UNF-2B (SAE-5)
(81-120 PSI) Use 43T37557

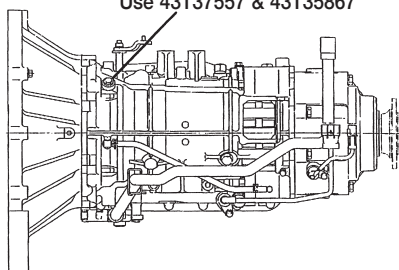

TOP VIEW

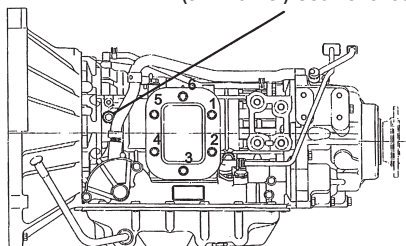

VIEWED FROM LEFT SIDE

AISIN AUTOMATIC TRANSMISSION 6-SPEED

For Dodge/Sterling Bullet 2007 thru 2011 Using Separate Instructions IN07-03

2013 AS69RC AS66RC Port Location. See instruction I3195 for Dodge installation.

Pressure Lube Port
4-22 PSI
Optional lubrication port
for Dodge 2012 and later is
located on the passenger
side in front of the PTO pad.

Main Pressure Tap
116-260 PSI
Port #1

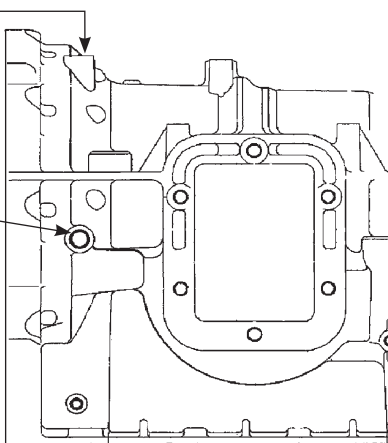

Ports ½-20 UNF-2B (SAE-5)

Locate the two pressure ports on the Left side of the Aisin 6-speed automatic transmission.

Connect Main Pressure to port #1 on CS6 solenoid valve as shown in the Electric/Hydraulic Clutch Shift instructions.

Connect the pressure lubrication hose to the Pressure Lube Port "P" as shown in the Electric/Hydraulic Clutch Shift instructions.

AISIN MY600 AND A465, ISUZU, AND HINO

This diagram shows the correct porting that is to be used when connecting the Muncie Power PTO to the Aisin MY600 and A465 automatic transmissions. The TG Series PTO uses only the top lubrication port to lubricate the PTO.

The CS6 Series PTO uses the top lubrication port as well as the main pressure port, located on the left side of the transmission in front of the PTO opening.

The solenoid activation valve supplied with the PTO connects to the main pressure port.

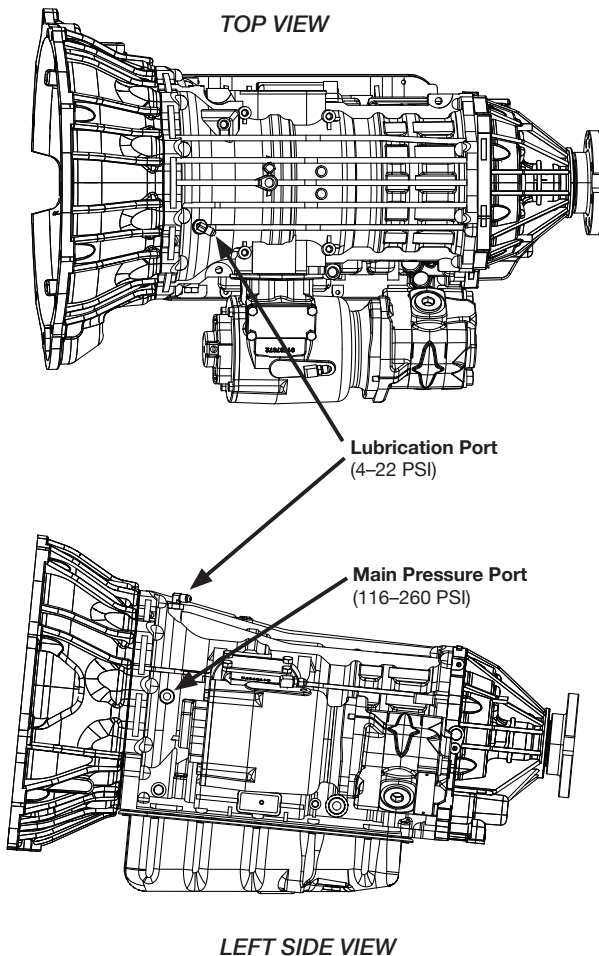

LUBRICATION PORT
TG or CS PTO
1/2 - 20UNF-2B
Use 43T39222 Fitting

MAIN PRESSURE PORT
CS PTO Only
1/2 - 20UNF-2B
Use 43T39222 Fitting

465HD Transmission Plumbing

The TG Series PTO uses only the top lubrication port to lubricate the PTO.

The CS6 Series PTO uses the top lubrication port as well as the main pressure port, located on the left side of the transmission in front of the PTO opening.

The solenoid activation valve supplied with the PTO connects to the main pressure port.

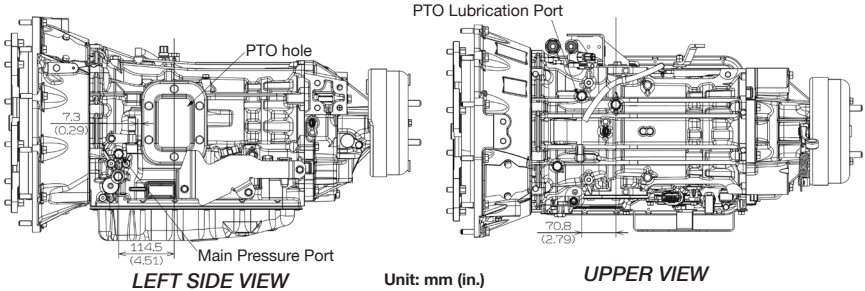

LUBRICATION PORT
TG or CS PTO
1/2 - 20UNF-2B
4-22 PSI at Port
Use 43T39222 Fitting

MAIN PRESSURE PORT
CS PTO Only
1/2 - 20UNF-2B
116-260 PSI at Port
Use 43T39222 Fitting

465id Transmission Plumbing

The TG Series PTO uses only the top lubrication port to lubricate the PTO.

The CS6 Series PTO uses the top lubrication port as well as the main pressure port, located on the left side of the transmission in front of the PTO opening.

The solenoid activation valve supplied with the PTO connects to the main pressure port.

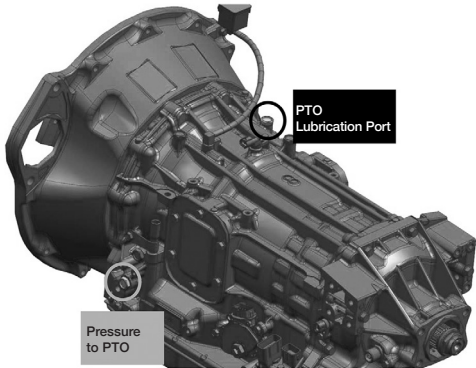

A465id

LUBRICATION PORT
TG or CS PTO
1/2 - 20UNF-2B
4-22 PSI at Port
Use 43T39222 Fitting

MAIN PRESSURE PORT
CS PTO Only
1/2 - 20UNF-2B
116-260 PSI at Port
Use 43T39222 Fitting

AUTOMATIC TRANSMISSION DIAGRAMS APPLICATION INFORMATION

ALLISON TRANSMISSION

RIGHT PROFILE

MODEL

LEFT PROFILE

LUBE TAP (PORT B)
3/4 "O" RING 50-70 P.S.I.

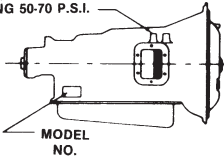

AT-540
4 SPEED
Lube Fitting
No. 43TK5191 Required
Must be ordered separately

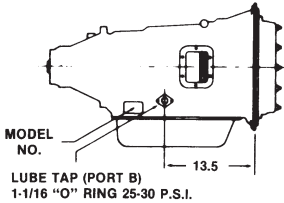
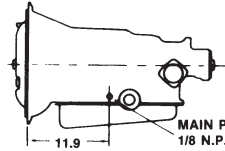

MT-600
4 & 5 SPEED SERIES
Lube Fitting
No. 43TK5157 Required
Must be ordered separately

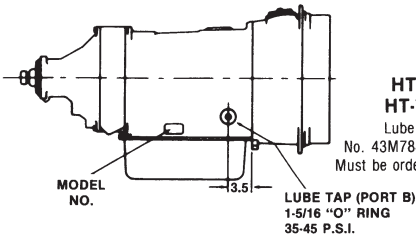
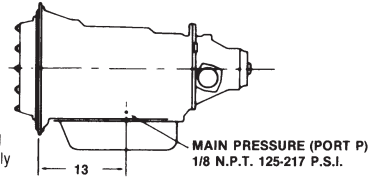

HT-740
HT-750D
Lube Fitting
No. 43M78897 Required
Must be ordered separately

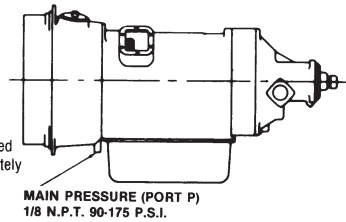

ALLISON AUTOMATIC TRANSMISSION 1000 SERIES™, 1700 SERIES™, 2000 SERIES™, 2400 SERIES™, AND 2700 SERIES™

4-Bolt Mount - #2 Housing
2-Bolt Mount - #3 Housing

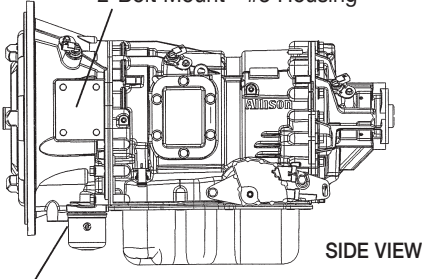

Main Pressure ("P") 100-260 PSI
.44-20 UNF-2A (-4)
43T36431 Fitting and
43T36445 Elbow Fitting Required

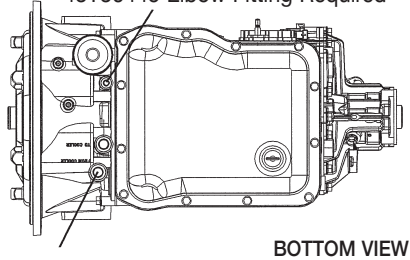

Locate Main Pressure Tap on Bottom of Transmission Converter

GM (Only) Applications:

On GM3600 Cab Chassis, the cooling lines enter the side of the transmission case, use 43TK4497 for lubrication line installation.

Use lube kit 43TK4497 on C3500 & C3600 Chassis.

Use lube kit 43TK4503 on discontinued C6500-C8500 Chassis.

Tee or Tap Into Return Cooler Port for PTO Pressure Lubrication (Where Required)

(SAE-8) 1000 Series (#3 Housing) use 43TK5191 Tee Fitting

(SAE-12) 1000, 1700, 2000, and 2700 Series (#2 Housing) use 43TK5157 Tee Fitting

Port size -12 is now common for all Allison 1000/2000 Series except for the GM 3500 version.

ALLISON AUTOMATIC TRANSMISSION 1000 SERIES™ OR 2000 SERIES™

When using the Allison transmission for stationary operation it is beneficial to engage the torque converter lock-up. This allows for a direct comparison of the output shaft speed to engine speed, without the affects of the torque converter.

Muncie Power Products requires an electrical connection to the vehicle TCM terminal J106 (WTEC II) or Pin 43 (Gen 4 or 5) reference Allison documentation for PTO enable. This notifies the transmission that a PTO is active and will allow for increased transmission activation pressures and transmission torque converter lock-up.

The Allison automatic transmission special wiring instructions depend on the chassis. Please refer to body builder's manuals and special instructions listed there for connection of Muncie Power PTOs. It is required that clutch shifted PTOs mounted to the Allison 1000 Series or 2000 Series be wired to the Allison transmission control. The "PTO enable" circuitry provided by Allison allows for full PTO output specifications. This means that the PTO enable circuit must be located and connected.

CS6B Series

Depending on the Chassis used connection to the PTO enable terminal can be accomplished by attaching a wire to the switched power from the PTO rocker switch and connecting it to the J106 terminal (WTEC II) or Pin 43 (Gen 4 or 5).

TG Series

Cable, lever, and air shifted PTOs can be install with either a two terminal switch or the use of a standard automotive relay as shown in the Figure 10 or Figure 11 below.

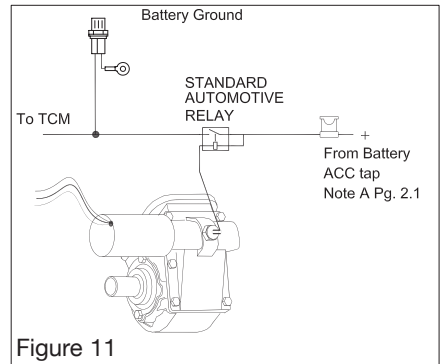
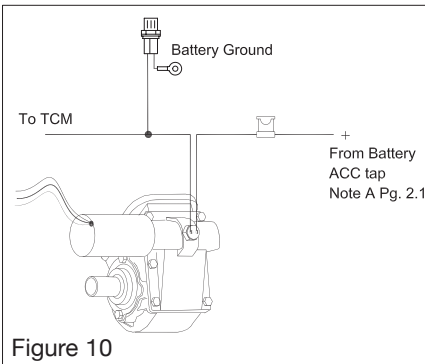

CLUTCH SHIFT & SH STANDARD AIR SHIFT SYSTEM

For Use When Air Shifting CS/CB Series or SH Series PTOs

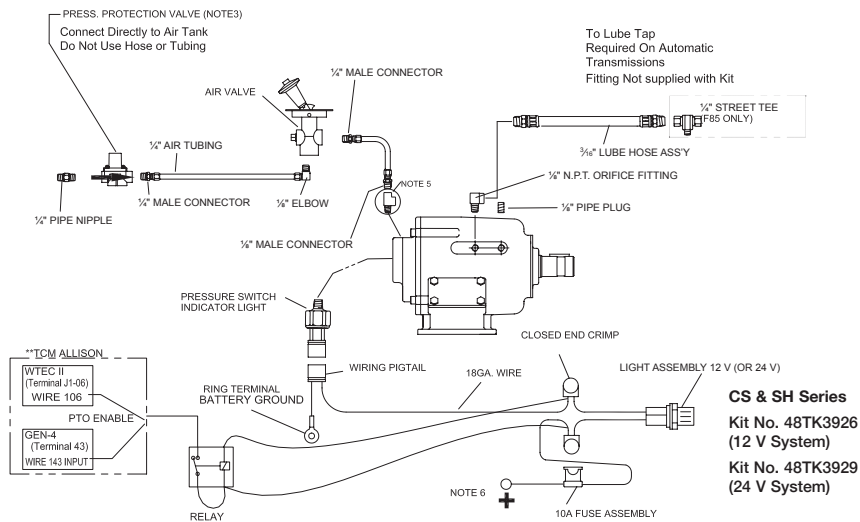

SYSTEM PROTECTION DEVICE (CS SERIES ONLY)

SPD-2000 Series sold separately.

Refer to IN22-07 for SPD-2000 Series Installations.

FOOTNOTES

1. Green light in rocker switch is to turn "ON" when PTO is engaged and to turn "OFF" when PTO is disengaged.
2. Solenoid valve should be mounted on firewall to protect it from corrosive environment.
3. Air System Users: You will not receive any air through the pressure protection valve to the PTO system until your main tank pressure exceeds 65 PSI. Some chassis' have dual air systems. Be sure to connect to the MAIN air supply tank or to the connection specified by the vehicle manufacturer.
4. Hydraulic hoses and hose ends not supplied with standard installation kit. Order Muncie 131-2-0001 separately.
5. Street Tee provided for clearance mount of pressure switch or for CS6G installation, be sure to plug unused port(s).
6. Connection to positive battery ACC tap as identified by chassis manufacturer. See note 1 on page 12.

CLUTCH SHIFT ELECTRIC/HYDRAULIC SHIFT SYSTEM

For Hydraulic Shifting CS/CB Series PTO on Automatic Transmissions

On Automatic Transmissions with externally, solenoid controlled converter neutral lock-up, install the ClutchShift activation circuit completely separate of the lock-up circuit. Do not use the same valve to operate both circuits.

TO TRANSMISSION
MAIN PRESSURE PORT "P"

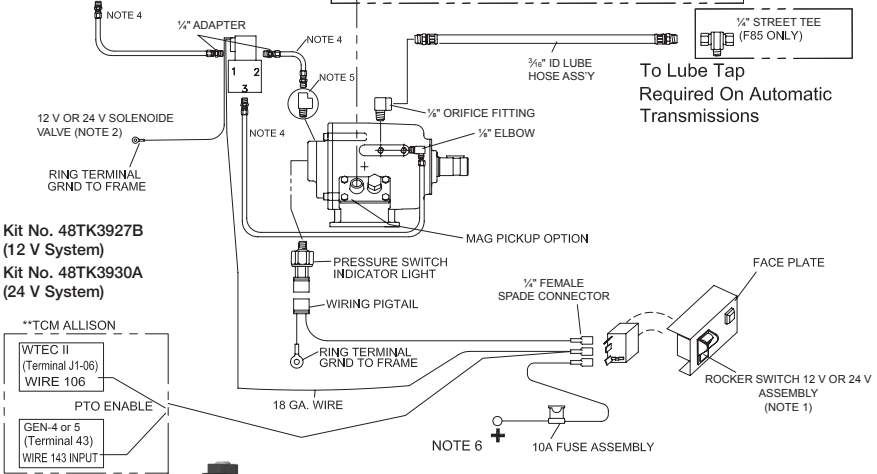
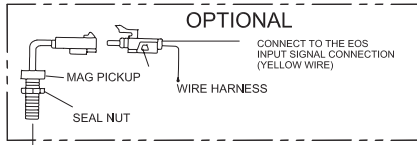

Kit No. 48TK3927B
(12 V System)
Kit No. 48TK3930A
(24 V System)

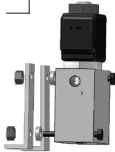
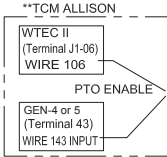

Do not mount solenoid to a flat surface without spacing the block with washers. Damage to valve will occur if coil is allowed to bind against any surfaces.

CLUTCH SHIFT & SH HEAVY ELECTRIC/ AIR SHIFT SYSTEM

For Use When Air Shifting CS/CB Series or SH Series PTOs

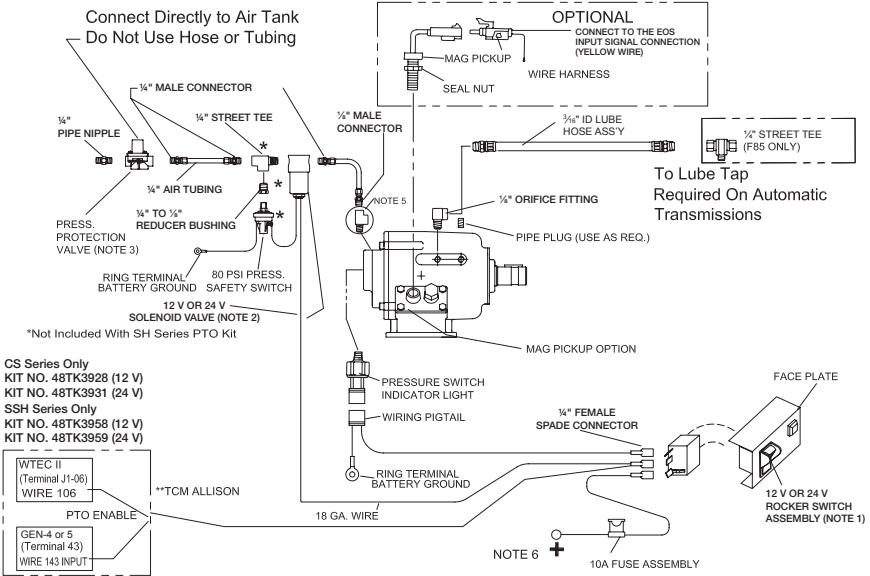

CLUTCH SHIFT ELECTRIC/HYDRAULIC SHIFT SYSTEM

For Hydraulic Shifting CS/CB Series PTO with Integral Solenoid on Automatic Transmission

Step 1: Locate the lube hose kit (43TK3934) and connect the lube port elbow to the PTO housing as shown.

Step 2: Remove the red plastic plug and insert the elbow into the PTO cover as shown. Connect the supplied hose assembly to the elbow and connect the other end of the hose assembly to the transmission.

Step 3: Connect the pressure lube hose assembly to the lube port elbow and connect the other end of the lube hose assembly to the transmission.

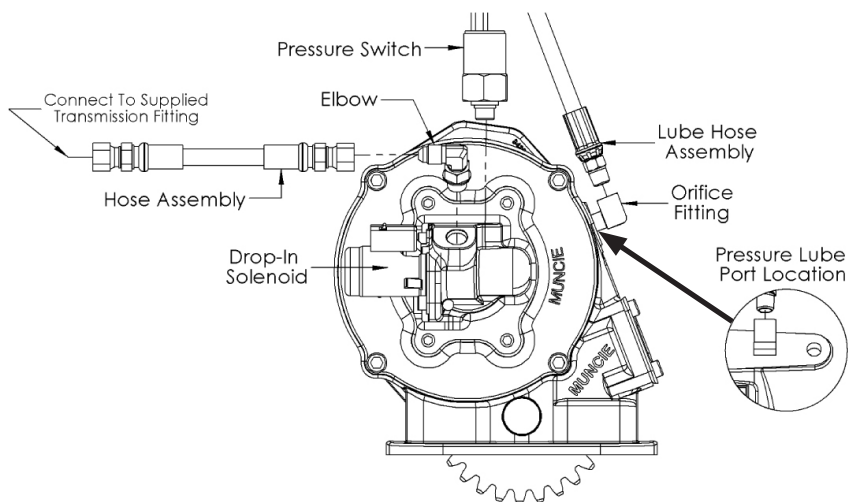

CLUTCH SHIFT INSTRUCTIONS & TESTS

1. Install the appropriate shifter kit components described on pages 23–28. On Allison and Aisin Automatic installations be sure that the lube orifice fitting is installed in the PTO housing port as shown on Figure 12. Use only the fitting supplied with your kit to assure proper transmission function.

Allison transmissions with neutral lock-up should be installed on a circuit separate of PTO shift circuit. The circuits are supplied by the transmission main pressure and should be teed together at, and closest to, the main pressure port (port “P”) as shown on diagrams found on pages 23–28.

2. With ignition switch on (but engine not running) turn on the PTO control switch and listen for solenoid valve. You should be able to hear valve snap open. If not, check for a poor ground connection. The ground must be a bare metal contact to frame.
3. Start engine and engage PTO with switch. If PTO fails to operate or will not develop enough torque to operate your equipment, check pressures as follows:

- a. **Stop engine.**

- b. Install 400 PSI pressure gauge at PTO piston port. (Figure 12) (150 PSI gauge for air systems).

- c. Install a second 400 PSI pressure gauge in front of screen adapter at solenoid valve. (Figure 12) (150 PSI gauge for air systems).

- d. Start engine. Stay clear of rotating components. Place PTO switch in engage position.

- e. If either gauge registers less than 90 PSI, or if there is more than 50 PSI difference at any engine speed, check for obstructions in the hoses or the screen adapter.

- f. On the hydraulic system if the gauge (Figure 13) registers 50 PSI or less, you may be connected to the wrong port on the transmission. Recheck the transmission information for the main pressure tap location on your model.

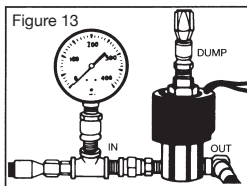
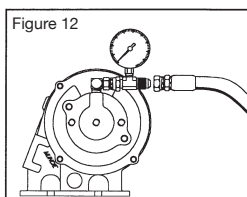

4. **Complete installation by placing warning labels as indicated on borders of the decals. Placement examples are illustrated on pages 1 and 2.**

Upon installation, the Clutch Shift output shaft may operate in the off position. If this occurs, double check plumbing for restrictions in the lines. If OK, adjustment of the drag brake may be required. Clutch Shift requires a minimal load on the output shaft.

The CS6 & CS8 PTO is equipped with an internal drag brake as standard. The brake is adjustable, should the output shaft continue to turn once PTO is disengaged. **Note:** This brake will **not** stop shaft if there is a catastrophic failure with PTO clutch pack. See Section 3 for more information.

Drag Brake Adjustment Procedure:

- a. **Stop engine.**

- b. Locate adjustment screws on the end cover per the diagram.

- c. Using $\frac{3}{16}$ " Allen wrench turn each of the set screws $\frac{1}{4}$ turn clockwise.

- d. Move away from under the vehicle

and away from possible moving components and restart the engine. Look for the output shaft to stop turning. If the shaft continues, then **shut the engine off** and repeat steps 2 through 4.

For U60, F85, I84 & I85 PTOs install 1 spring per hole in these 2 holes. No springs in other holes. (Mark these 2 screws with red paint.)

For all other ratios install 1 spring per hole in all 4 holes. (Do not paint these screws.)

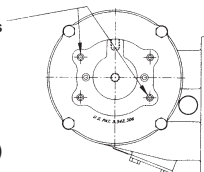

COVER END VIEW

SECTION 3

OPERATOR'S MANUAL





POWER TAKE-OFF SHIFTING PROCEDURE & PRECAUTIONS

POWER TAKE-OFF OPERATION - VEHICLE STATIONARY

 WARNING—PARKING BRAKE MUST ALWAYS BE SET

 WARNING—VEHICLE'S WHEELS MUST ALWAYS BE CHOCKED

 WARNING—TRANSMISSION MUST ALWAYS BE IN NEUTRAL OR PARK

 WARNING—AN OPERATOR MUST ALWAYS BE IN THE DRIVER'S SEAT WHENEVER THE ENGINE IS RUNNING AND THE TRANSMISSION IS IN GEAR, IN ORDER TO PREVENT OR STOP ANY UNEXPECTED MOVEMENT OF THE VEHICLE WHICH MAY CAUSE INJURIES TO THE OPERATOR OR OTHERS IN THE VICINITY.

- Read all operator's manuals and instructions for the equipment that you are operating on this vehicle.
- Obtain instructions and training for all operations of the equipment on this vehicle including those not covered by this instruction booklet.
- Never work alone when repairing or going under a vehicle for repair or maintenance.
- Always block any raised or moveable components or devices when working on or around the vehicle as specified by the equipment manufacturer.
- Warning: PTOs may drive driven equipment with an exposed drive shaft which may cause severe injury or death if contacted.
- Care must be taken when using a PTO for any specific application that the PTO has been properly specified to match the transmission and auxiliary equipment. Improper specification and installation can cause severe damage to the vehicle transmission and the auxiliary components including driveshafts and driven equipment. Damaged components, equipment resulting in failure can cause serious personal injury to operators and persons in the vicinity.
- Always follow recommended procedures for selecting, installing, operating, or repairing a PTO as found in Muncie Power Products operator's manuals, service parts lists and service manuals, catalogs, and application guides.
- Never use a Muncie Power PTO above the recommended operating speed of the unit or the specified driven unit.
- Never use a PTO that has not been specified for the output capabilities for the equipment being driven.

ROTATING PTO DRIVE SHAFTS

It is recommended that direct couple hydraulic pumps be used whenever possible, but if your application requires the use of an exposed drive shaft it is the responsibility of the installer and purchaser to determine the best installation of a guard.

- Rotating shaft can snag clothing, skin, hands, hair, etc. and will cause serious injury or death.
- Do not go under the vehicle when the engine is running.
- Do not work near an exposed drive shaft with engine running.
- Auxiliary shaft can be installed with recessed or protruding set screws. If raised, square head set screws are chosen, then be aware that this is a catch point for clothes, skin, hair, hands, etc., and serious injury or death may result.

The output shaft of a PTO with internal clutch packs may rotate in cold temperatures with the PTO disengaged. PTO shaft rotation can cause sudden movement of the output shaft and attached drive shaft leading to personal injury or death. Allow transmission to operate for a few minutes before engaging PTO. Allow PTO to operate for a few minutes before actuating application controls.

Some O.E.M. chassis manufacturers have integrated electronic controls which require certain conditions to be met before engaging a PTO. These include, but are not limited to setting parking brake, foot off service brake, engine at idle, foot off accelerator pedal, and or transmission selector in park or neutral.

1. Mechanical Transmission

- a. A PTO is, and should be, operated as an integral part of the main transmission.
- b. Before shifting the PTO into or out of gear, disengage the clutch and wait for transmission or PTO gears to stop rotating.

2. Automatic Transmission with Manual Shift PTOs (includes Air Shift) — Manual Shift PTOs include TG, SH, RL, and 82 Series PTOs

On automatic transmissions, the gears in the transmission turn when the transmission is in neutral, therefore, gear clashing will occur if the Power Take-off is shifted *into gear (engaged)* or *out of gear (disengaged)* at this time.

With Converter Driven Gear:

- a. Engine idle. With the operator seated in the driver's seat and while activating the vehicle's brake, shift transmission lever into any of the drive positions. (This will stop transmission gear from turning.)
- b. Shift PTO into or out of gear.
- c. If the PTO does not engage release the PTO to the disengage position, shift the transmission to neutral and repeat the above steps from step A.
- d. Shift transmission into park or neutral. (This will start transmission gears turning.) If you hear a grinding or ratcheting sound turn PTO off and repeat these procedures from step A.

3. Automatic Transmission/Transfer Case Mounted PTO (Also SS66 Split Shaft PTO)

- a. Shift transmission into park.
- b. **Caution: Apply parking brake and block wheels. Note: Applying parking brake does not insure that vehicle will not move when transfer case is in neutral.**
- c. Engage PTO.

- d. Shift transfer case into neutral.
- e. Shift transmission into drive to activate PTO output shaft. Caution: Do not place the transmission selector in park or reverse while PTO is operational as damage to PTO or driven unit may occur.

To Disengage PTO:

- f. **Shut off** engine with transmission in drive mode.
- g. Disengage PTO.
- h. Shift transmission selector to park.
- i. Restart engine.
- j. Remove wheel blocks and release parking brake.
- k. Shift transfer case into engaged mode.
- l. Vehicle can now be driven.

Failure to follow proper shifting or operating sequences will result in premature PTO failure with possible damage to the equipment.

CLUTCH SHIFT OPERATING NOTES

CLUTCH SHIFT PTOs should not be engaged (turned “ON”) under heavy load and/or at engine speeds over 1,000 RPM. If your operators are careless or negligent in this respect, you can safeguard your equipment with one or more Muncie Power's protective systems.

Consult your Muncie Power product literature or call your nearest Muncie Power Center for information on the SPD System Protection Device which prevents engagement of your CLUTCH SHIFT PTO above safe speeds.

The red overspeed light on the PTO control switch panel is for use with the SPD and will indicate an overspeed condition when wired according to instructions in the SPD Installation Manual.

Upon installation, CLUTCH SHIFT output shaft may rotate while in the off position. If this occurs, recheck plumbing for restrictions in the lines. If the plumbing is okay, adjustment of drag brake will be required. The Clutch Shift requires a minimal load on the output shaft. See your PTO installer or refer to page 29 for adjustment instructions. The CB Series does not require adjustment.

PTO MAINTENANCE

The Power Take-off, being an integral part of the transmission, should be serviced at the same intervals as the transmission. Transmission fluid changes should follow the interval recommended by the vehicle manufacturer for severe service. Transmission oil level is important. Checking for PTO leaks and checking the transmission oil level should be done on a regular basis.

Check for leaks upon delivery of the vehicle and after initial operation of your equipment. Loss of any oil can significantly affect or damage a transmission or PTO. Muncie Power Products, Inc. is not responsible for damage resulting from improper fastener installation, mounting torque or maintenance of the PTO.

The Power Take-off is also part of a *system*. The PTO system may include the activation control parts, a driveshaft, or hydraulic pump. This PTO system requires periodic checks and service. Typically the interval for maintenance checks of the PTO system depends on the application of the system. Every time the chassis is lubricated or a mechanic is under the vehicle the PTO system should be checked and serviced. For severe duty PTO system applications, it is recommended that the system be checked for service every 100 hours of use (this guideline can be adjusted based on past service history once you

have it established). Service should include checking and lubricating direct mount pump shaft connections. PTO gears can be checked for wear by removing the inspection or shifter cover. If pitting, galling, cracking, or deformation of the gears or splines has occurred, then the PTO needs to be rebuilt or replaced.

Within the first week of use, recheck the installation of the PTO. Check for leaks and loose mounting hardware (studs, cap screws, nuts). Recheck the cable or lever connections for proper adjustment and tighten any loose connections. At regular maintenance intervals, check adjustments and lubricate moving parts, tighten and repair the connections, mounting hardware, cable or lever linkages.

It is recommended that the operator/owner do a visual inspection for leaks under and around the vehicle and equipment on at least a weekly basis. Any leaks found should be corrected immediately.

Pumps that are mounted directly to the PTO output require the application of an anti-seize or a high temperature, high pressure grease. (Muncie Power PTOs are initially supplied with the required grease.) The purpose of this grease is to help make the PTO easier to service and to reduce the effects of fretting corrosion on the mating PTO and pump shafts. PTO applications under severe duty cycles and/or high torque requirements may require servicing this shaft connection by periodically re-greasing the shafts. Vehicles with low speed diesel engines are also severe applications due to the vibrations inherent in these vehicles. Fretting corrosion cannot be stopped by applying grease, the grease is only a deterrent.

INDICATOR LIGHT CHECK



Procedure for checking the PTO Indicator Switch is found on Page 18



**STOP ENGINE.
TRUCK IS NOT TO BE RUNNING
WHEN PREFORMING THIS TEST.**



**STOP ENGINE.
TRUCK IS NOT TO BE RUNNING
WHEN PREFORMING THIS TEST.
ROCKER SWITCH IS TO BE
TURNED OFF DURING THIS TEST.**

Temporarily ground the terminal to check bulb.

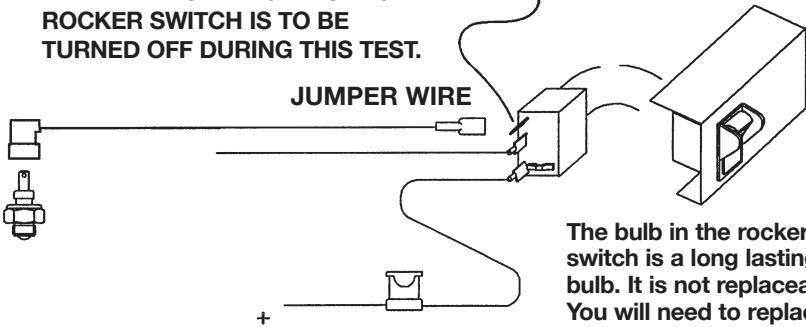

The bulb in the rocker switch is a long lasting bulb. It is not replaceable. You will need to replace switch if bulb fails.

PTO TORQUE & HORSEPOWER RATINGS

Intermittent service refers to an On-Off operation under load. If maximum horsepower and/or torque is used for extended periods of time, (5 minutes or more) this is considered “Continuous Service” and the horsepower rating of the PTO should be reduced by multiplying the value below by .70.

PTO SERIES	SPEED RATIO	INTERMITTENT HP @ 1,000 RPM	INTERMITTENT KW @ 1,000 RPM	TORQUE LBS.FT.	TORQUE NM	MAX. SPEED
TG	04	54	40.3	285	386	2,500
	05	51	38	270	366	2,500
	06	47	35	245	332	2,500
	07	44	32.8	230	312	2,500
	08	44	32.8	230	312	2,500
	09	39	29	205	278	2,500
	12H	40	29.8	210	285	2,500
	13H	40	29.8	210	285	2,500
	15H	37	27.6	195	264	2,500
	18H	33	24.6	175	237	2,500
SH	05	76	57	400	542	2,500
	07	76	57	400	542	2,500
	09	71	53	375	508	2,500
	12	62	46	325	441	2,500
	13	62	46	325	441	2,500
CS	03	57	42.5	300	407	2,500
	04	57	42.5	300	407	2,500
	05	57	42.5	300	407	2,500
	06	57	42.5	300	407	2,500
	07	57	42.5	300	407	2,500
	09	52	38.8	275	373	2,500
	12	52	38.8	275	373	2,500
	14	52	38.8	275	373	2,500
RL	03	38	28.3	200	271	2,500
	05	38	28.3	200	271	2,500
82	05	95	70.8	500	678	2,500
	08	85	63.4	450	610	2,500
	09	78	58.2	410	556	2,500
	10	78	58.2	410	556	2,500
	12	71	52.9	375	508	2,500
	13	71	52.9	375	508	2,500
	15	67	49.9	350	475	2,500
	19	57	42.5	300	407	2,500

PTO TROUBLESHOOTING GUIDE

PROBLEM	POSSIBLE CAUSE	REMEDY	PREVENTION
CABLE SHIFT PTOS			
Hard shifting	Cable inner member frozen	Thaw in garage	Route cable away from road spray and seal end from moisture
	Sharp bend in cable	Straighten inner member or replace cable	Keep bends larger than the minimum bend radius, avoid short cable runs
	Improper shifting	Make sure vehicle clutch is adjusted to allow the PTO drive gear to stop before shifting or that the proper shift procedure is followed	See Section 3
	Worn or damaged shift control	Repair or replace components	Do not connect lever rods to cable shifters
Delayed or partial engagement	Loose linkage or attachment; loose or missing cable clamps	Repair or replace	Routine maintenance
AIR SHIFT PTOS			
PTO doesn't engage	Contaminated air lines	Remove contaminants from air cylinder	Bleed air system more often
	Air pressure not high enough	Wait until system pressure is above 65 PSI before engaging PTO	Systems are designed with a pressure protection valve which does not allow air to the PTO until the system pressure exceeds 65 PSI
	Improper method of shifting causing damage to the PTO shift collar	Make sure vehicle clutch is adjusted to allow the PTO drive gear to stop before shifting or that the proper shift procedure is followed	See Section 3
	Worn or damaged shift controls	Repair or replace components	
	Repair or replace components	Reassemble onto PTO correctly	
PTO doesn't disengage	Faulty air valve	Repair or replace	Usually a result of contamination or dirty valve, keep air system bled and valves free of dirt
	Worn or damaged shift control	Repair or replace components	
	Shift fork is out of shift collar	Reassemble onto PTO correctly	

PTO TROUBLESHOOTING GUIDE *continued*

PROBLEM	POSSIBLE CAUSE	REMEDY	PREVENTION
LECTRA SHIFT PTOS			
PTO doesn't engage	Loose connection	Review wiring diagrams in Section 2	Make sure wires are properly supported and connections are properly made
	Poor/improper grounding of electrical circuit	Make all grounds to the vehicle battery	Control module is very sensitive to proper ground
	Blown fuse	Replace fuse with proper rating	Make proper connections
	Improper shifting	Make sure vehicle clutch is adjusted to allow the PTO drive gear to stop before shifting or that the proper shift procedure is followed	See Section 3
	Worn or damaged shift control	Repair or replace components	
CLUTCH SHIFT PTOS			
PTO doesn't engage	Contaminated air lines	Remove contaminants from air cylinder	Bleed air system more often
	Air pressure not high enough	Wait until system pressure is above 65 PSI before engaging PTO or 80 PSI for the Electric/Air System	Electric/Air Systems are designed with a pressure protection switch which does not allow current to the PTO valve until the system pressure exceeds 65 PSI
	Air lines are too long	Re-route lines directly to air tanks	Follow installation diagrams
	Hydraulic line connected to wrong port	Review installation diagrams in Section 2	
	Burned or extremely worn clutch pack	Replace worn components	
	Engine RPM too high (SPD)	Adjust SPD See IN22-02 for SPD-2000 Series	
PTO doesn't disengage	Hydraulic or air lines connected to wrong ports on valve control	Re-route lines	Refer to installation diagrams in Section 2
	Faulty air or hydraulic valve	Repair or replace components	Sometimes a result of contamination or dirty valve, keep air system bled and valves free of dirt
	Burned or extremely worn clutch pack	Repair or replace components	Follow proper engagement procedures in Section 3
	Misadjusted drag brake	Adjust brake with adjustment screws, see Section 2	

POWER TAKE-OFF WARRANTY

The Muncie Power Take-off is warranted to be free of defects in material or workmanship and to meet Muncie's standard written specifications at the time of sale. Muncie's obligation and liability under this warranty is expressly limited to repairing or replacing, at Muncie's option, within one year after date of original installation any defective part or parts or any product not meeting the specifications.

THIS WARRANTY IS IN LIEU OF ALL OTHER WARRANTIES, EXPRESSED OR IMPLIED. MUNCIE MAKES NO WARRANTY OF MERCHANTABILITY OR OF FITNESS FOR ANY PARTICULAR PURPOSE. MUNCIE'S OBLIGATION UNDER THIS WARRANTY SHALL NOT INCLUDE ANY TRANSPORTATION CHARGES OR COSTS OF INSTALLATION OR ANY LIABILITY FOR DIRECT, INDIRECT SPECIAL, INCIDENTAL, OR CONSEQUENTIAL DAMAGES OR DELAY. THE REMEDIES SET FORTH HEREIN ARE EXCLUSIVE, AND MUNCIE'S LIABILITY WITH RESPECT TO ANY CONTRACT OR SALE OR ANYTHING DONE IN CONNECTION THEREWITH, WHETHER IN CONTRACT, IN TORT, UNDER ANY WARRANTY, OR OTHERWISE, SHALL NOT, EXCEPT AS EXPRESSLY PROVIDED HEREIN, EXCEED THE PRICE OF THE PRODUCT OR PART ON WHICH SUCH LIABILITY IS BASED.

If requested by Muncie, products or parts for which a warranty claim is made are to be returned transportation prepaid to a Muncie Service Center. Any installation or use not in accordance with catalogue or package instructions, other improper use, operation beyond capacity, substitution of parts not approved by Muncie, use with equipment other than the equipment on which the Power Take-off is first installed, or alteration or repair made to the Power Take-Off other than at a Muncie Service Center shall void this warranty. No employee or representative of Muncie is authorized to change this warranty in any way or to grant any other warranty.



**Muncie®
Power
Products**

A Member of the Interpump Group

201 East Jackson Street, Muncie, Indiana 47305
800-367-7867 • Fax: 765-284-6991
info@munciepower.com

Specifications are subject to change without notice.
Visit www.munciepower.com for warranties and literature. All rights reserved. © Muncie Power Products, Inc. (2013)